

Convergence of lattice trees to super-Brownian motion above the critical dimension

Mark Holmes*
Department of Statistics
The University of Auckland
Private Bag 92019
Auckland 1142
New Zealand
Email: mholmes@stat.auckland.ac.nz

Abstract

We use the *lace expansion* to prove asymptotic formulae for the Fourier transforms of the *r*-point functions for a spread-out model of critically weighted lattice trees in \mathbb{Z}^d for $d > 8$. A lattice tree containing the origin defines a sequence of measures on \mathbb{Z}^d , and the statistical mechanics literature gives rise to a natural probability measure on the collection of such lattice trees. Under this probability measure, our results, together with the appropriate limiting behaviour for the survival probability, imply convergence to super-Brownian excursion in the sense of finite-dimensional distributions .

Key words: Lattice trees, super-Brownian motion, lace expansion.

AMS 2000 Subject Classification: Primary 82B41, 60F05, 60G57, 60K35.

Submitted to EJP on June 6, 2007, final version accepted April 3, 2008.

*supported in part by UGFs from the University of British Columbia.

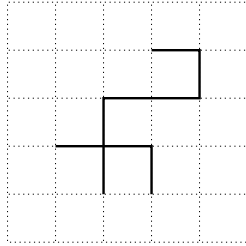

Figure 1: A nearest neighbour lattice tree in 2 dimensions.

1 Introduction

A *lattice tree* in \mathbb{Z}^d is a finite connected set of bonds containing no cycles (see Figure 1). Lattice trees are an important model for branched polymers. They are of interest in statistical physics, and perhaps combinatorics and graph theory. We expect that our results are also appealing to probabilists, since there is a critical lattice tree weighting scheme and a corresponding sequence of measures that are believed to converge (in dimensions $d > 8$) to the canonical measure of super-Brownian motion, a well-known measure in the superprocesses literature. The main result of this paper establishes asymptotic formulae for the Fourier transforms of the so-called r -point functions, which goes part way to proving this convergence result. The 2-point function $t_n(x)$, is (up to scaling) the probability that a (critically weighted) random lattice tree containing the origin, also contains the point $x \in \mathbb{Z}^d$ at tree-distance n from the origin.

Lattice trees are self-avoiding objects by definition (since they contain no cycles). It is plausible that the self-avoidance constraint imposed by the model becomes less important as the dimension increases. Lubensky and Isaacson [23] proposed $d_c = 8$ as the critical dimension for lattice trees and animals, at which various critical exponents cease to depend on the dimension and take on their mean-field values (with \log corrections when $d = 8$). Macroscopic properties of the model should be similar to a simpler model, called branching random walk, that does not have the self-avoidance constraint. A good source of information on critical exponents for lattice trees (self-avoiding branched polymers) is [7]. There are few rigorous results for lattice trees for $1 < d \leq 8$. The scaling limit of the model in 2 dimensions is not expected to be conformally invariant, so that the class of processes called *Stochastic Loewner Evolution (SLE)* (see for example [27]) is not a suitable candidate for the scaling limit. Brydges and Imbrie [3] used a dimensional reduction approach to obtain strong results for a continuum (i.e. not lattice based) model for $d = 2, 3$. Appealing to universality, we would expect lattice trees to have the same critical exponents as the Brydges and Imbrie model.

In high dimensions much more is known. Let $\rho_{p_c}(x) = \sum_n t_n(x)$. Hara and Slade [9], [10] proved the finiteness of the *square diagram* $\sum_{x,y,z} \rho_{p_c}(x)\rho_{p_c}(y-x)\rho_{p_c}(z-y)\rho_{p_c}(z)$ for sufficiently spread-out lattice trees for $d > 8$, and for the nearest neighbour model for $d \gg 8$. With van der Hofstad [8], they showed mean-field behaviour of $\rho_{p_c}(x)$ for a sufficiently spread-out model when $d > 8$. Derbez and Slade [6] studied sufficiently spread-out lattice trees containing exactly N bonds (hence $N + 1$ vertices) under the same critical weighting scheme, and in dimensions $d > 8$. They verified (in the sufficiently spread-out setting) a conjecture of Aldous [2] that says that in the limit as N goes to infinity (with appropriate scaling), one obtains a random probability

measure on \mathbb{R}^d called integrated super-Brownian excursion (ISE). The ISE is essentially what one gets from integrating super-Brownian excursion (whose law is the canonical measure of super-Brownian motion) over time and conditioning the resulting random measure to have total mass 1. In this paper the total mass is unrestricted and the temporal component of the trees and limiting process is retained.

Results of Hara and Slade (see for example [24]) show that for $d > 4$, self-avoiding walk (SAW) converges to Brownian motion in the scaling limit. This is achieved by proving convergence of the finite-dimensional distributions and tightness. In this case tightness follows from a negative correlation property of the model. Note that, almost surely, Brownian motion paths have Hausdorff dimension $2 \wedge d$ and are self-avoiding in 4 or more dimensions.

With appropriate scaling of space, time, and mass, critical branching random walk converges weakly to super-Brownian motion (see for example [25]). One version of this statement is that $\mu_n \xrightarrow{w} \mathbb{N}_0$ (as (sigma-finite) measures on the space $D(M_F(\mathbb{R}^d))$ of *cadlag* finite-measure-valued paths on \mathbb{R}^d), where $\mu_n \in M_F(D(M_F(\mathbb{R}^d)))$ is an appropriate scaling of the law of the correspondingly scaled branching random walk, and \mathbb{N}_0 is a sigma-finite measure on $D(M_F(\mathbb{R}^d))$, called the canonical measure of super-Brownian motion (CSBM). Denote by X_t a measure-valued path with law \mathbb{N}_0 . The supports of the measures $Y_{[t_0, t_1]} = \int_{t_0}^{t_1} X_s ds$ and $Y_{[t_2, t_3]} = \int_{t_2}^{t_3} X_s ds$ have no intersection in dimensions $d \geq 8$ if $t_2 > t_1$ (\mathbb{N}_0 -almost everywhere) [5]. This is the appropriate way to say that SBM is self-avoiding for $d \geq 8$. We might expect that critical lattice trees (described as a measure-valued process with appropriate scaling) converge weakly to CSBM in the same sense as branching random walk, for $d > 8$.

In this paper we use the lace expansion to prove asymptotic formulae for the Fourier transforms of quantities called the r -point functions, for critical sufficiently spread-out lattice trees in dimensions $d > 8$. Holmes and Perkins [21] prove that these formulae, together with an appropriate asymptotic formula for the survival probability, imply convergence of the model to CSBM in the sense of finite-dimensional distributions. Tightness and the asymptotics of the survival probability remain open problems. Similar results have been obtained for critical spread-out models of oriented percolation [18], [13], [14] and the contact process [16] above their critical dimension (see also [11] and [12] for ordinary percolation). For a comprehensive introduction to the lace expansion and its applications up to 2005, see [26].

1.1 The model

We proceed to define the quantities of interest. We restrict ourselves to the vertex set of \mathbb{Z}^d .

Definition 1.1.

1. A bond is an unordered pair of distinct vertices in the lattice.
2. A cycle is a set of distinct bonds $\{v_1 v_2, v_2 v_3, \dots, v_{l-1} v_l, v_l v_1\}$, for some $l \geq 3$.
3. A lattice tree is a finite set of vertices and lattice bonds connecting those vertices, that contains no cycles. This includes the single vertex lattice tree that contains no bonds.
4. Let $r \geq 2$ and let $x_i, i \in \{1, \dots, r\}$ be vertices in a lattice tree T . Since T contains no cycles, there exists a minimal connected subtree containing all the x_i , called the skeleton

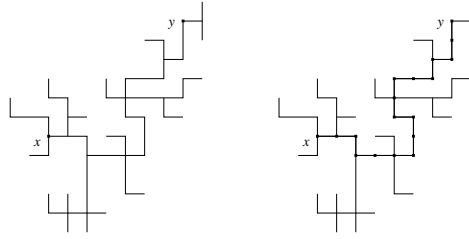

Figure 2: A nearest neighbour lattice tree in 2 dimensions. The backbone from x to y of length $n = 17$ is highlighted in the second figure.

connecting the x_i . If $r = 2$ we often refer to the skeleton connecting x_1 to x_2 as the backbone.

Remark 1.2. The nearest-neighbour model consists of nearest neighbour bonds $\{x_1, x_2\}$ with $x_1, x_2 \in \mathbb{Z}^d$ and $|x_1 - x_2| = 1$. Figures 1 and 2 show examples of nearest-neighbour lattice trees in \mathbb{Z}^2 .

We use \mathbb{Z}_+ to denote the nonnegative integers $\{0, 1, 2, \dots\}$.

Definition 1.3.

1. For $\vec{x} \in \mathbb{Z}^{dl}$ let $\mathcal{T}(\vec{x}) = \{T : x_i \in T, i \in 1, \dots, l\}$. Note that $\mathcal{T}(x)$ always includes the single vertex lattice tree, $T = \{x\}$ that contains no bonds.
2. For $T \in \mathcal{T}(o)$ we let T_i be the set of vertices $x \in T$ such that the backbone from o to x consists of i bonds. In particular for $T \in \mathcal{T}(o)$ we have $T_o = \{o\}$. A tree $T \in \mathcal{T}(o)$ is said to survive until time n if $T_n \neq \emptyset$.
3. For $\vec{\mathbf{x}} = (x_1, \dots, x_{r-1}) \in \mathbb{Z}^{d(r-1)}$ and $\vec{\mathbf{n}} \in \mathbb{Z}_+^{r-1}$ we write $\vec{\mathbf{x}} \in T_{\vec{\mathbf{n}}}$ if $x_i \in T_{n_i}$ for each i and define $\mathcal{T}_{\vec{\mathbf{n}}}(\vec{\mathbf{x}}) \equiv \{T \in \mathcal{T}(o) : \vec{\mathbf{x}} \in T_{\vec{\mathbf{n}}}\}$.

If we think of $T \in \mathcal{T}(o)$ as the path taken by a migrating population in discrete time, then T_i can be thought of as the set of locations of particles alive at time i . Figure 3 identifies the set T_{10} for a fixed T . Similarly $\mathcal{T}_{\vec{\mathbf{n}}}(\vec{\mathbf{x}})$ can be thought of as the set of trees for which there is a particle at x_i alive at time n_i for each i .

In order to provide a small parameter needed for convergence of the lace expansion, we consider trees consisting of bonds connecting vertices separated by distance at most L for some $L \gg 1$. Each bond is weighted according to a function D , supported on $[-L, L]^d$ with total mass 1. The methods and results in this paper rely heavily on the main results of [8] and [17]. Since the assumptions on the model are stronger in [8], we adopt the finite range L, D spread-out model of that paper. The following definition and the subsequent remark are taken, almost verbatim from [8].

Definition 1.4. Let h be a non-negative bounded function on \mathbb{R}^d which is piecewise continuous, symmetric under the \mathbb{Z}^d -symmetries of reflection in coordinate hyperplanes and rotation by $\frac{\pi}{2}$,

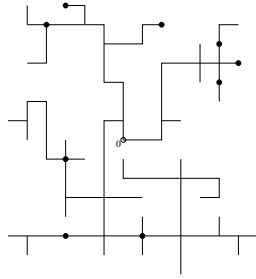

Figure 3: A nearest neighbour lattice tree T in 2 dimensions with the set T_i for $i = 10$.

supported in $[-1, 1]^d$, and normalised ($\int_{[-1, 1]^d} h(x) d^d x = 1$). Then for large L we define

$$D(x) = \frac{h(x/L)}{\sum_{x \in \mathbb{Z}^d} h(x/L)}. \quad (1.1)$$

Remark 1.5. Since $\sum_{x \in \mathbb{Z}^d} h(x/L) \sim L^d$ using a Riemann sum approximation to $\int_{[-1, 1]^d} h(x) d^d x$, the assumption that L is large ensures that the denominator of (1.1) is non-zero. Since h is bounded, $\sum_{x \in \mathbb{Z}^d} h(x/L) \sim L^d$ also implies that

$$\|D\|_\infty \leq \frac{C}{L^d}.$$

We define $\sigma^2 = \sum_x |x|^2 D(x)$. The sum $\sum_x |x|^r D(x)$ can be regarded as a Riemann sum and is asymptotic to a multiple of L^r for $r > 0$. In particular σ and L are comparable. A basic example obeying the conditions of Definition 1.4 is given by the function $h(x) = 2^{-d} I_{[-1, 1]^d}(x)$ for which $D(x) = (2L + 1)^{-d} I_{[-L, L]^d \cap \mathbb{Z}^d}(x)$.

Definition 1.6 (L, D spread-out lattice trees). Let $\Omega_D = \{x \in \mathbb{Z}^d : D(x) > 0\}$. We define an L, D spread-out lattice tree to be a lattice tree consisting of bonds $\{x, y\}$ such that $y - x \in \Omega_D$.

The results of this paper are for L, D spread-out lattice trees in dimensions $d > 8$. Appealing to the hypothesis of universality, we expect that the results also hold for nearest-neighbour lattice trees. However from this point on, unless otherwise stated, “lattice trees” and related terminology refers to L, D spread-out lattice trees.

Definition 1.7 (Weight of a tree). Given a finite set of bonds B and a nonnegative parameter p , we define the weight of B to be

$$W_{p, D}(B) = \prod_{\{x, y\} \in B} p D(y - x),$$

with $W_{p, D}(\emptyset) = 1$. If T is a lattice tree we define

$$W_{p, D}(T) = W_{p, D}(B_T),$$

where B_T is the set of bonds of T .

Definition 1.8 ($\rho(x)$). *Let*

$$\rho_p(x) = \sum_{T \in \mathcal{T}(x)} W_{p,D}(T).$$

Clearly we have $\rho_p(o) \geq 1$ for all L, p since the single vertex lattice tree $\{o\}$ contains no bonds and therefore has weight 1. A standard subadditivity argument [22] shows that there is a finite, positive p_c at which $\sum_x \rho_p(x)$ converges for $p < p_c$ and diverges for $p > p_c$. Hara, van der Hofstad and Slade [8] proved the following Theorem, in which $\mathcal{O}(y)$ denotes a quantity that is bounded in absolute value by a constant times y .

Theorem 1.9. *Let $d > 8$ and fix $\nu > 0$. There exists a constant \bar{A} (depending on d and L) and an L_0 (depending on d and ν) such that for $L \geq L_0$,*

$$\rho_{p_c}(x) = \frac{\bar{A}}{\sigma^2(|x| \vee 1)^{d-2}} \left[1 + \mathcal{O} \left(\frac{L^{(d-8)\wedge 2}}{(|x| \vee 1)^{((d-8)\wedge 2) - \nu}} \right) + \mathcal{O} \left(\frac{L^2}{(|x| \vee 1)^{2-\nu}} \right) \right]. \quad (1.2)$$

Constants in the error terms are uniform in both x and L , and \bar{A} is bounded above uniformly in L .

We henceforth take our trees at criticality and write

$$W(\cdot) = W_{p_c,D}(\cdot), \quad \text{and} \quad \rho(x) = \rho_{p_c}(x). \quad (1.3)$$

It was also shown in [8] that $p_c \rho(o) \leq 1 + \mathcal{O}(L^{-2+\nu})$ and

$$\rho(x) \leq C \left(I_{x=0} + \frac{I_{x \neq 0}}{L^{2-\nu} (|x| \vee 1)^{d-2}} \right), \quad (1.4)$$

where the constants in the above statements depend on ν and d , but not L .

1.2 The r -point functions

In this section we define the main quantities of interest in this paper, the r -point functions, and state the main results.

Definition 1.10 (2-point function). *For $\zeta \geq 0$, $n \in \mathbb{N}$, and $x \in \mathbb{R}^d$ we define,*

$$t_n(x; \zeta) = \zeta^n \sum_{T \in \mathcal{T}_n(o,x)} W(T). \quad (1.5)$$

We also define $t_n(x) = t_n(x; 1)$.

Definition 1.11 (Fourier Transform). *Given an absolutely summable function $f : \mathbb{Z}^{d(r-1)} \rightarrow \mathbb{R}$, we let $\hat{f}(k) = \sum_{x_1, \dots, x_{r-1}} e^{i \sum_{j=1}^{r-1} k_j \cdot x_j} f(\vec{x})$ denote the Fourier transform of f ($k_j \in [-\pi, \pi]^d$).*

In [17] the authors show that if a recursion relation of the form

$$f_{n+1}(k; z) = \sum_{m=1}^{n+1} g_m(k; z) f_{n+1-m}(k; z) + e_{n+1}(k; z) \quad (1.6)$$

holds, and certain assumptions S, D, E, and G on the functions f_\bullet , g_\bullet and e_\bullet hold, then there exists a critical value z_c of z such that $f_n(k, z_c)$ (appropriately scaled) converges (up to a constant factor) to the Fourier transform of the Gaussian density as $n \rightarrow \infty$. In [15] this result is extended by generalizing assumptions E and G according to a parameter $\theta > 2$, where the special case $\theta = d/2$ with $d > 4$ is that which is proved in [17]. In Section 3.1 we show that $\hat{t}_n(k; \zeta)$ obeys the recursion relation

$$\hat{t}_{n+1}(k; \zeta) = \sum_{m=1}^{n+1} \hat{\pi}_{m-1}(k; \zeta) \zeta p_c \hat{D}(k) \hat{t}_{n+1-m}(k; \zeta) + \hat{\pi}_{n+1}(k; \zeta),$$

where $\pi_m(x; \zeta)$ is a function that is defined in Section 3.1. After massaging this relation somewhat, the important ingredients in verifying assumptions E and G for our lattice trees model are bounds on $\hat{\pi}_m$ using information about $\rho(x)$ and $\hat{t}_l(k; \zeta)$ for $l < m$. The quantities $\hat{\pi}_{m-1}(k; \zeta)$ are reformulated using a technique known as the *lace expansion*, which is discussed in Section 2 and ultimately reduces the problem to one of studying certain Feynman diagrams. As in some of the references already discussed, the critical dimension $d_c = 8$ appears in this analysis as the dimension above which the *square diagram*

$$\rho^{(4)}(o) = \sum_{x,y,z} \rho(x) \rho(y-x) \rho(z-y) \rho(z)$$

converges.

The parameter ζ appears in (1.10) as an additional weight on bonds in the backbone of trees $T \in \mathcal{T}_n(x)$. Those trees are already critically weighted by p_c (a weight present on *every* bond in the tree) as described by Definition 1.7 and (1.3) and exhibit mean-field behaviour in the form of Theorem 1.9. One might therefore expect a Gaussian limit for \hat{t}_n with $\zeta = 1$. The following theorem is proved using the induction approach of [15], together with a short argument showing that the critical value of ζ obtained from the induction is $\zeta_c = 1$.

Theorem 1.12. *Fix $d > 8$, $t > 0$, $\gamma \in (0, 1 \wedge \frac{d-8}{2})$ and $\delta \in (0, (1 \wedge \frac{d-8}{2}) - \gamma)$. There exists a positive $L_0 = L_0(d)$ such that: For every $L \geq L_0$ there exist positive A and v depending on d and L such that*

$$\hat{t}_{\lfloor nt \rfloor} \left(\frac{k}{\sqrt{v\sigma^2 n}} \right) = A e^{-\frac{|k|^2}{2d} t} + \mathcal{O} \left(\frac{|k|^2}{n} \right) + \mathcal{O} \left(\frac{|k|^2 t^{1-\delta}}{n^\delta} \right) + \mathcal{O} \left(\frac{1}{(nt \vee 1)^{\frac{d-8}{2}}} \right),$$

with the error estimate uniform in $\{k \in \mathbb{R}^d : |k|^2 \leq Ct^{-1} \log(\lfloor nt \rfloor \vee 1)\}$, where $C = C(\gamma)$ and the constants in the second and third error terms may depend on L .

More generally, we consider lattice trees containing the origin and $r - 1$ other fixed points at fixed times.

Definition 1.13 (r -point function). *For $r \geq 3$, $\tilde{\mathbf{n}} \in \mathbb{N}^{r-1}$ and $\tilde{\mathbf{x}} \in \mathbb{R}^{d(r-1)}$ we define*

$$t_{\tilde{\mathbf{n}}}^r(\tilde{\mathbf{x}}) = \sum_{T \in \mathcal{T}_{\tilde{\mathbf{n}}}(\tilde{\mathbf{x}})} W(T). \tag{1.7}$$

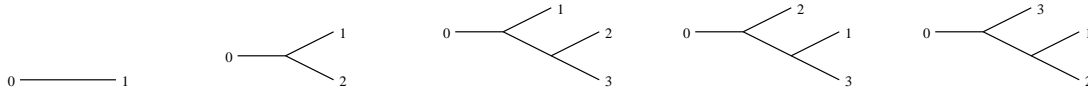

Figure 4: The unique shape $\alpha(r)$ for $r = 2, 3$ and the 3 shapes for $r = 4$.

To state a version of Theorem 1.12 for r -point functions for $r > 3$ we need the notion of *shapes*, which are abstract (partially labelled) sets of vertices and edges connecting those vertices, with special binary tree topologies.

The *degree* of a vertex v is the number of edges incident to v . Vertices of degree 1 are called *leaves*. Vertices of degree ≥ 3 are called *branch points*. There is a unique shape for $r = 2$ consisting of 2 vertices (labelled 0, 1) connected by a single edge. The vertex labelled 0 is called the *root*. For $r \geq 3$ we have $\prod_{j=3}^r (2j - 5)$ r -shapes obtained by adding a vertex to any of the $2(r - 1) - 3$ edges of each $(r - 1)$ -shape, and a new edge to that vertex. The leaf of this new edge is labelled $r - 1$. Each r -shape has $2r - 3$ edges, labelled in a fixed but arbitrary manner as $1, \dots, 2r - 3$. This is illustrated in figure 4 which shows the shapes for $r = 2, 3, 4$. Let Σ_r denote the set of r -shapes. By convention, the edges in $\alpha \in \Sigma_r$ are directed away from the root. By construction each r -shape has $r - 2$ branch points, each of degree 3.

Given a shape $\alpha \in \Sigma_r$ and $\tilde{\mathbf{k}} \in \mathbb{R}^{(r-1)d}$ we define $\vec{\kappa}(\alpha) \in \mathbb{R}^{(2r-3)d}$ as follows. For each leaf j in α (other than 0) we let E_j be the set of edges in α of the unique path in α from 0 to j . For $l = 1, \dots, 2r - 3$, we define

$$\kappa_l(\alpha) = \sum_{j=1}^{r-1} k_j I_{\{l \in E_j\}}. \quad (1.8)$$

Next, given α and $\vec{s} \in \mathbb{R}_+^{(2r-3)}$ we define $\tilde{\zeta}(\alpha) \in \mathbb{R}_+^{(r-1)}$ by

$$\zeta_j(\alpha) = \sum_{l \in E_j} s_l.$$

Finally we define

$$R_{\tilde{\mathbf{t}}}(\alpha) = \{\vec{s} : \tilde{\zeta}(\alpha) = \tilde{\mathbf{t}}\}.$$

This is an $(r - 2)$ -dimensional subset of $\mathbb{R}_+^{(2r-3)}$. For $r = 3$ we simply have

$$R_{\tilde{\mathbf{t}}}(\alpha) = \{(s, t_1 - s, t_2 - s) : s \in [0, t_1 \wedge t_2]\}.$$

It is known [1] that for $r \geq 2$, $0 < t_1 < t_2 \cdots < t_{r-1}$ and $\phi_k(x) = e^{ik \cdot x}$,

$$\mathbb{E}_{\mathbb{N}_0} \left[\prod_{j=1}^{r-1} X_{t_j}(\phi_{k_j}) \right] = \sum_{\alpha \in \Sigma_r} \int_{R_{\tilde{\mathbf{t}}}(\alpha)} \prod_{l=1}^{2r-3} e^{-\frac{\kappa_l(\alpha)^2 s_l}{2d}} d\vec{s}, \quad (1.9)$$

where $X_t(\phi) \equiv \int \phi(x) X_t(dx)$, and $\mathbb{E}_{\mathbb{N}_0}$ denotes integration with respect to the sigma-finite measure \mathbb{N}_0 . For $r = 3$ this reduces to

$$\int_0^{t_1 \wedge t_2} e^{-\frac{(k_1+k_2)^2 s}{2d}} e^{-\frac{k_1^2 (t_1-s)}{2d}} e^{-\frac{k_2^2 (t_2-s)}{2d}} ds. \quad (1.10)$$

Theorem 1.14. Fix $d > 8$, and $\delta \in (0, (1 \wedge \frac{d-8}{2}))$. There exists $L_0 = L_0(d) \gg 1$ such that: for each $L \geq L_0$ there exists $V = V(d, L) > 0$ such that for every $\tilde{\mathbf{t}} \in (0, \infty)^{(r-1)}$, $r \geq 3$, $\mathcal{K} > 0$, and $\|\tilde{\mathbf{k}}\|_\infty \leq \mathcal{K}$,

$$\hat{t}_{\lfloor n\tilde{\mathbf{t}} \rfloor}^r \left(\frac{\tilde{\mathbf{k}}}{\sqrt{v\sigma^2 n}} \right) = n^{r-2} V^{r-2} A^{2r-3} \left[\sum_{\alpha \in \Sigma_r} \int_{R_{\tilde{\mathbf{t}}}(\alpha)} \prod_{l=1}^{2r-3} e^{-\frac{\kappa_l(\alpha)^2 s_l}{2d}} d\vec{s} + \mathcal{O}\left(\frac{1}{n^\delta}\right) \right], \quad (1.11)$$

where the constant in the error term depends on $\tilde{\mathbf{t}}, \mathcal{K}, \delta$ and L , and $\|\tilde{\mathbf{k}}\|_\infty$ is the supremum norm $\sup_i |\mathbf{k}_i|$.

Theorem 1.14 is proved in Section 4 using a version of the lace expansion on a tree of [19]. The proof proceeds by induction on r , with Theorem 1.12 as the initializing case. Lattice trees $T \in \mathcal{T}_{\tilde{\mathbf{n}}}(\tilde{\mathbf{x}})$ can be classified according to their skeleton (recall Definition 1.1). Such trees typically have a skeleton with the topology of some $\alpha \in \Sigma_r$ and the lace expansion and induction hypothesis combine to give the main contribution to (1.11). The relatively few trees that do not have the topology of any $\alpha \in \Sigma_r$ are considered separately and are shown to contribute only to the error term of (1.11).

1.3 A measure-valued “process”

Let $M_F(\mathbb{R}^d)$ denote the space of finite measures on \mathbb{R}^d with the weak topology and $\mathcal{B}(D)$ denote the Borel σ -algebra on D . For each $i, n \in \mathbb{N}$ and each lattice tree T , we define a finite measure $X_{\frac{i}{n}}^{n,T} \in M_F(\mathbb{R}^d)$ by

$$X_{\frac{i}{n}}^{n,T} = \frac{1}{VA^2n} \sum_{x: \sqrt{v\sigma^2 n}x \in T_i} \delta_x, \quad (1.12)$$

where $\delta_x(B) = I_{x \in B}$ for all $B \in \mathcal{B}(\mathbb{R}^d)$. Figure 3 shows a fixed tree T and the set T_i for $i = 10$. For this T , the measure $X_{\frac{10}{n}}^{n,T}$ assigns mass $(VA^2n)^{-1}$ to each vertex in the set $T_{10}/\sqrt{v\sigma^2 n} \equiv \{x : \sqrt{v\sigma^2 n}x \in T_{10}\}$. We extend this definition to all $t \in \mathbb{R}^+$ by

$$X_t^{n,T} = X_{\frac{\lfloor nt \rfloor}{n}}^{n,T},$$

so that for fixed n and T , we have $\{X_t^{n,T}\}_{t \geq 0} \in D(M_F(\mathbb{R}^d))$.

Next we must decide what we mean by a “random tree”. We define a probability measure \mathbb{P} on the countable set $\mathcal{T}(o)$ by $\mathbb{P}(\{T\}) = \rho(o)^{-1}W(T)$, so that

$$\mathbb{P}(B) = \frac{\sum_{T \in B} W(T)}{\rho(o)}, \quad B \subset \mathcal{T}(o). \quad (1.13)$$

Lastly we define the measures $\mu_n \in M_F(D(M_F(\mathbb{R}^d)))$ by

$$\mu_n(H) = VA\rho(o)n\mathbb{P} \left(\{T : \{X_t^{n,T}\}_{t \in \mathbb{R}_+} \in H\} \right), \quad H \in \mathcal{B}(D(M_F(\mathbb{R}^d))). \quad (1.14)$$

The constants in the definition of μ_n have been chosen because of (1.9), (1.11) and the relationship

$$\mathbb{E}_{\mu_n} \left[\prod_{j=1}^{r-1} X_{t_j}^n(\phi_{k_j}) \right] = VA\rho(o)n\mathbb{E}_{\mathbb{P}} \left[\prod_{j=1}^{r-1} X_{t_j}^{n,T}(\phi_{k_j}) \right] = \frac{VA\rho(o)n}{\rho(o)(VA^2n)^{r-1}} \hat{t}_{\lfloor n\tilde{\mathbf{t}} \rfloor}^r \left(\frac{\tilde{\mathbf{k}}}{\sqrt{\sigma^2 vn}} \right). \quad (1.15)$$

Given a measure-valued path $X = \{X_t\}_{t \geq 0}$ let $S(X) = \inf\{t > 0 : X_t(1) = 0\}$ denote the extinction time of the path. It is known [21] that convergence of μ_n to \mathbb{N}_0 in the sense of finite-dimensional distributions for dimensions $d > 8$ follows from Theorems 1.12 and 1.14 together with the conjectured result for the survival probability $\mu_n(S > \epsilon) \rightarrow \mathbb{N}_0(S > \epsilon)$. It is also known [21] that Theorems 1.12 and 1.14 imply the following Theorem, in which $\{X_t^n\}$ denotes a process chosen according to the finite measure μ_n and $\{\vec{X}_t\}$ denotes *super-Brownian excursion*, i.e. a measure-valued path chosen according to the σ -finite measure \mathbb{N}_0 . We also use \mathcal{D}_F to denote the set of discontinuities of a function F . A function $Q : M_F(\mathbb{R}^d)^m \rightarrow \mathbb{R}$ is called a *multinomial* if $Q(\vec{X})$ is a real multinomial in $\{X_1(1), \dots, X_m(1)\}$. A function $F : M_F(\mathbb{R}^d)^m \rightarrow \mathbb{C}$ is said to be *bounded by a multinomial* if there exists a multinomial Q such that $|F| \leq Q$.

Theorem 1.15. *There exists $L_0 \gg 1$ such that for every $L \geq L_0$, with μ_n defined by (1.14) the following hold:*

For every $s, \lambda > 0$, $m \geq 1$, $\vec{t} \in [0, \infty)^m$ and every $F : M_F(\mathbb{R}^d)^m \rightarrow \mathbb{C}$ bounded by a multinomial and such that $\mathbb{N}_0(\vec{X}_{\vec{t}} \in \mathcal{D}_F) = 0$,

$$\mathbb{E}_{\mu_n} \left[F(\vec{X}_{\vec{t}}^n) X_s^n(1) \right] \rightarrow \mathbb{E}_{\mathbb{N}_0} \left[F(\vec{X}_{\vec{t}}) X_s(1) \right], \quad \text{and} \quad (1.16)$$

$$\mathbb{E}_{\mu_n} \left[F(\vec{X}_{\vec{t}}^n) I_{\{X_s^n(1) > \lambda\}} \right] \rightarrow \mathbb{E}_{\mathbb{N}_0} \left[F(\vec{X}_{\vec{t}}) I_{\{X_s(1) > \lambda\}} \right]. \quad (1.17)$$

The factors in Theorem 1.15 involving the total mass at time s , are essentially two ways of ensuring that our convergence statements are about finite measures. In particular these factors ensure that there is no contribution from paths with arbitrarily small lifetime.

The remainder of this paper is organized as follows. In Section 2 we explain the lace construction that will be used in bounding diagrams arising from the lace expansion. We apply the lace expansion to prove Theorems 1.12 and 1.14 in Sections 3 and 4, assuming certain diagrammatic bounds. These bounds are proved in Sections 5 and 6 respectively.

2 The lace expansion

The lace expansion on an interval was introduced in [4] for weakly self-avoiding walk, and was applied to lattice trees in [9; 10; 6; 8]. It has also been applied to various other models such as strictly self-avoiding walk, oriented and unoriented percolation, and the contact process. The lace expansion on a tree was introduced and applied to networks of mutually avoiding SAW joined with the topology of a tree in [19]. It was subsequently used to study networks with arbitrary topology [20]. In this section we closely follow [19] although we require modifications to the definitions of connected graphs and laces to suit the lattice trees setting. In Section 2.1 we introduce our terminology and define and construct laces on star-shaped networks of degree 1 or 3. In Section 2.3 we analyse products of the form $\prod_{st \in \mathcal{N}} [1 + U_{st}]$ and perform the lace expansion in a general setting. Such products will appear in formulas for the r -point functions in Sections 3 and 4.

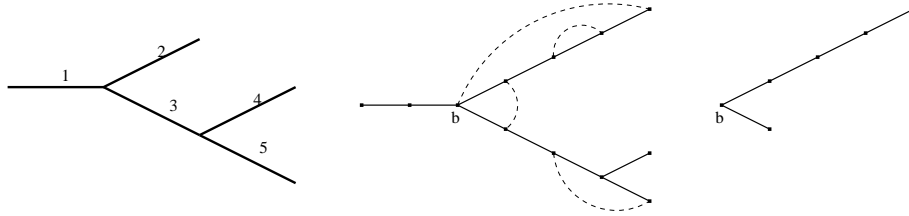

Figure 5: A shape $\alpha \in \Sigma_r$ for $r = 4$ with fixed branch labellings, followed by a graph Γ on $\mathcal{N}(\alpha, (2, 4, 3, 1, 1))$, and the subnetwork $\mathcal{A}_b(\Gamma)$.

2.1 Graphs and Laces

Given a shape $\alpha \in \Sigma_r$, and $\vec{n} \in \mathbb{N}^{2r-3}$ we define $\mathcal{N} = \mathcal{N}(\alpha, \vec{n})$ to be the *skeleton network* formed by inserting $n_i - 1$ vertices into edge i of α , $i = 1, \dots, 2r - 3$. Thus edge i in α becomes a path consisting of n_i edges in \mathcal{N} .

A *subnetwork* $\mathcal{M} \subseteq \mathcal{N}$ is a subset of the vertices and edges of \mathcal{N} such that if uv is an edge in \mathcal{M} then u and v are vertices in \mathcal{M} . Fix a connected subnetwork $\mathcal{M} \subseteq \mathcal{N}$. The *degree* of a vertex v in \mathcal{M} is the number of edges in \mathcal{M} incident to v . A vertex of \mathcal{M} is a *leaf* (resp. *branch point*) of \mathcal{M} if it is of degree 1 (resp. 3) in \mathcal{M} . A *path* in \mathcal{M} is any connected subnetwork $\mathcal{M}_1 \subset \mathcal{M}$ such that \mathcal{M}_1 has no branch points. A *branch* of \mathcal{M} is a path of \mathcal{M} containing at least two vertices, whose two endvertices are either leaves or branch points of \mathcal{M} , and whose interior vertices (if they exist) are not leaves or branch points of \mathcal{M} . Note that if $b' \in \mathcal{M}_1 \subset \mathcal{M}$ is a branch point of \mathcal{M}_1 then it is also a branch point of \mathcal{M} . Similarly if $v \in \mathcal{M}_1 \subset \mathcal{M}$ is a leaf of \mathcal{M} then it is also a leaf of \mathcal{M}_1 . The reverse implications need not hold in general. Two vertices s, t are *branch neighbours* in \mathcal{M} if there exists some branch in \mathcal{M} of which s, t are the two endvertices (this forces s and t to be of degree 1 or 3). Two vertices s, t of \mathcal{M} are said to be *adjacent* if there is an edge in \mathcal{M} that is incident to both s and t .

For $r \geq 3$, let b denote the unique branch neighbour of the root in \mathcal{N} . If $r = 2$, let b be one of the leaves of \mathcal{N} . Without loss of generality we assume that the edge in α (and hence the branch in \mathcal{N}) containing the root is labelled 1 and we assume that the other two branches incident to b are labelled 2, 3. Vertices in \mathcal{N} may be relabelled according to branch and distance along the branch, with branches oriented away from the root. For example the vertices on branch 1 from the root 0 to the branch point b neighbouring the root (or leaf to leaf if $r = 2$) would be labelled $0 = (1, 0), (1, 1), \dots, (1, n_1) = b$.

Examples illustrating some of the following definitions appear in Figures 5-6.

Definition 2.1. Let $\mathcal{M} \subseteq \mathcal{N}$.

1. A *bond* is a pair $\{s, t\}$ of vertices in \mathcal{M} with the vertex labelling inherited from \mathcal{N} . Let $\mathbf{E}_{\mathcal{M}}$ denote the set of bonds of \mathcal{M} . The set of edges and vertices of the unique minimal path in \mathcal{M} joining (and including) s and t is denoted by $[s, t]$. The bond $\{s, t\}$ is said to cover $[s, t]$. We often abuse the notation and write st for $\{s, t\}$.
2. A *graph* on \mathcal{M} is a set of bonds. Let $\mathcal{G}_{\mathcal{M}}$ denote the set of graphs on \mathcal{M} . The graph containing no bonds will be denoted by \emptyset .

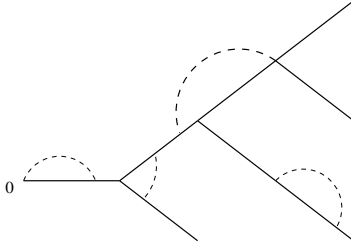

Figure 6: A graph $\Gamma \in \mathcal{G}(\mathcal{N})$ that contains a bond in \mathcal{R} .

3. Let $\mathcal{R} = \mathcal{R}_{\mathcal{M}}$ denote the set of bonds which cover more than one branch point of \mathcal{M} (see Figure 6). If $r \leq 3$ then $\mathcal{R} = \emptyset$ since in this case $\mathcal{M} \subseteq \mathcal{N}$ cannot have more than one branch point. Let $\mathcal{G}_{\mathcal{M}}^{-\mathcal{R}} = \{\Gamma \in \mathcal{G}_{\mathcal{M}} : \Gamma \cap \mathcal{R}_{\mathcal{M}} = \emptyset\}$, i.e. the set of graphs on \mathcal{M} containing no bonds in \mathcal{R} .
4. A graph $\Gamma \in \mathcal{G}_{\mathcal{M}}$ is a connected graph on \mathcal{M} if $\cup_{st \in \Gamma} [s, t] = \mathcal{M}$ (i.e. if every edge of \mathcal{M} is covered by some $st \in \Gamma$). Let $\mathcal{G}_{\mathcal{M}}^{\text{con}}$ denote the set of connected graphs on \mathcal{M} , and $\mathcal{G}_{\mathcal{M}}^{-\mathcal{R}, \text{con}} = \mathcal{G}_{\mathcal{M}}^{\text{con}} \cap \mathcal{G}_{\mathcal{M}}^{-\mathcal{R}}$.
5. A connected graph $\Gamma \in \mathcal{G}_{\mathcal{M}}^{\text{con}}$ is said to be minimal or minimally connected if the removal of any of its bonds results in a graph that is not connected (i.e. for every $st \in \Gamma$, $\Gamma \setminus st \notin \mathcal{G}_{\mathcal{M}}^{\text{con}}$).
6. Given $\Gamma \in \mathcal{G}_{\mathcal{M}}$ and a subnetwork $\mathcal{A} \subset \mathcal{M}$ we define $\Gamma|_{\mathcal{A}} = \{st \in \Gamma : s, t \in \mathcal{A}\}$.
7. Given a vertex $v \in \mathcal{M}$ and $\Gamma \in \mathcal{G}_{\mathcal{M}}$ we let $\mathcal{A}_v(\Gamma)$ be the largest connected subnetwork \mathcal{A} of \mathcal{M} containing v such that $\Gamma|_{\mathcal{A}}$ is a connected graph on \mathcal{A} . In particular $\mathcal{A}_v(\emptyset) = v$. Note that if \mathcal{A}_1 and \mathcal{A}_2 are connected subnetworks of \mathcal{M} containing v such that $\Gamma|_{\mathcal{A}_i}$ is a connected graph on \mathcal{A}_i , then $\mathcal{A}_1 \cup \mathcal{A}_2$ also has this property.
8. Let $\mathcal{E}_{\mathcal{N}}^b$ be the set of graphs $\Gamma \in \mathcal{G}_{\mathcal{N}}^{-\mathcal{R}}$ such that $\mathcal{A}_b(\Gamma)$ contains a vertex adjacent to some branch point $b' \neq b$ of \mathcal{N} . Note that this set is empty if $r \leq 3$, since then \mathcal{N} contains at most one branch point. Note also that if b is adjacent to another branch point of \mathcal{N} , then $\mathcal{E}_{\mathcal{N}}^b = \mathcal{G}_{\mathcal{N}}^{-\mathcal{R}}$, since $\mathcal{A}_b(\emptyset) = b$.

For $\Delta \in \{0, 1, 3\}$, $\vec{n} \in \mathbb{N}^{\Delta}$, let $\mathcal{S}_{\vec{n}}^{\Delta}$ denote the network consisting of Δ paths meeting at a common vertex v , where path i is of length $n_i > 0$ (i.e. it contains n_i edges). This is called a star-shaped network of degree Δ . By definition of our networks $\mathcal{N}(\alpha, \vec{n})$, with $\vec{n} \in \mathbb{N}^{2r-3}$, for any $\Gamma \in \mathcal{G}_{\mathcal{N}}^{-\mathcal{R}} \setminus \mathcal{E}_{\mathcal{N}}^b$, $\mathcal{A}_b(\Gamma)$ contains at most one branch point and is therefore a star-shaped subnetwork of degree 3 (if it contains a branch point), 1, or 0 (if $\mathcal{A}_b(\Gamma)$ is a single vertex). A star-shaped network \mathcal{S}_n^1 of degree 1 containing n edges may be identified with the interval $[0, n]$, since it contains no branch point. We therefore sometimes write $\mathcal{S}[0, n]$ for \mathcal{S}_n^1 . Note that the “missing” star-shaped network $\mathcal{S}_{(n_1, n_2)}^2$ of degree 2 may be identified with the star shaped network $\mathcal{S}_{n_1+n_2}^1$.

Figure 7 shows graphs on each of \mathcal{S}_8^1 and $\mathcal{S}_{(4,4,7)}^3$. The first graph in each case is connected, while the second is disconnected.

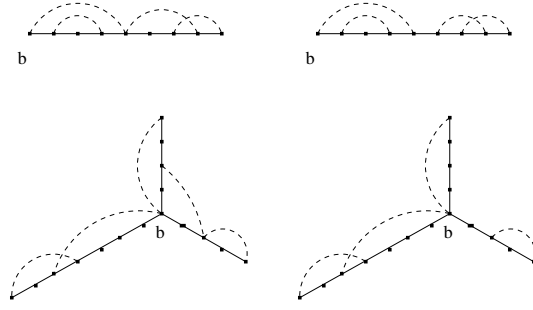

Figure 7: Two graphs on each of \mathcal{S}_8^1 and $\mathcal{S}_{(4,4,7)}^3$. The first graph for each star is connected. The second is disconnected. The connected graph on $\mathcal{S}_{(4,4,7)}^3$ is a lace while the connected graph on \mathcal{S}_8^1 is not a lace.

Definition 2.2. Fix a connected subnetwork $\mathcal{M} \subseteq \mathcal{N}$, containing more than 1 vertex. Let $\Gamma \in \mathcal{G}_{\mathcal{M}}^{-\mathcal{R}, \text{con}}$ be given and let v be a branch point of \mathcal{M} if such a branch point exists. Otherwise let v be one of the leaves of \mathcal{M} . Let $\Gamma_e^b \subset \Gamma$ be the set of bonds $s_i t_i$ in Γ which cover the vertex v and which have an endpoint (without loss of generality t_i) strictly on branch \mathcal{M}_e (i.e. t_i is a vertex of branch \mathcal{M}_e and $t_i \neq v$). By definition of connected graph, Γ_e^v will be nonempty. From Γ_e^v we select the set $\Gamma_e^{v, \text{max}}$ for which the network distance from t_i to v is maximal. We choose the bond associated to branch \mathcal{M}_e at v as follows:

1. If there exists a unique element $s_i t_i$ of $\Gamma_e^{v, \text{max}}$ whose network distance from s_i to v is maximal, then this $s_i t_i$ is the bond associated to branch \mathcal{M}_e at v .
2. If not then the bond associated to branch \mathcal{M}_e at v is chosen (from the elements $\Gamma_e^{v, \text{max}}$ whose network distances from s_i to v are maximal) to be the bond $s_i t_i$ with s_i on the branch of highest label.

Definition 2.3 (Lace). A lace on a star shape $\mathcal{S} = \mathcal{S}_{\vec{n}}^{\Delta}$, with $\vec{n} \in \mathbb{N}^{\Delta}$, $\Delta \in \{1, 3\}$ is a connected graph $L \in \mathcal{G}_{\mathcal{S}}^{\text{con}}$ such that:

- If $st \in L$ covers a branch point v of \mathcal{S} then st is the bond in L associated to some branch \mathcal{S}_e at v .
- If $st \in L$ does not cover such a branch point then $L \setminus \{st\}$ is not connected.

We write $\mathcal{L}(\mathcal{S})$ for the set of laces on \mathcal{S} , and $\mathcal{L}^N(\mathcal{S})$ for the set of laces on \mathcal{S} consisting of exactly N bonds.

See Figure 7 for some examples of connected graphs and laces. We now describe a method of constructing a lace \mathbf{L}_{Γ} from a given connected graph Γ , on a star-shaped network \mathcal{S} of degree 1 or 3. Note that the only (connected) graph on a star-shape of degree 0 (i.e. a single vertex) is the graph $\Gamma = \emptyset$ containing no bonds, and we define $\mathbf{L}_{\emptyset} = \emptyset$.

Definition 2.4 (Lace construction). Let \mathcal{S} be a star-shaped network of degree 1 or 3. In the latter case, b is the branch point, otherwise b denotes one of the leaves of \mathcal{S} . Fix $\Gamma \in \mathcal{G}_{\mathcal{S}}^{-\mathcal{R}, \text{con}}$. Let F be the set of branch labels for branches incident to b . For each e in F ,

- Let $s_1^e t_1^e$ be the bond in Γ associated to branch \mathcal{S}_e at b , and let b_e be the other endvertex of \mathcal{S}_e .
- Suppose we have chosen $\{s_1^e t_1^e, \dots, s_l^e t_l^e\}$, and that $\cup_{i=1}^l [s_i^e t_i^e]$ does not cover b_e . Then we define

$$\begin{aligned} t_{l+1}^e &= \max\{t \in \mathcal{S}_e : \exists s \in \mathcal{S}_e, s \leq_b t \text{ such that } st \in \Gamma\}, \\ s_{l+1}^e &= \min\{s \in \mathcal{S}_e : st_{l+1}^e \in \Gamma\}, \end{aligned} \tag{2.1}$$

where \max (\min) refers to choosing t (s) of maximum (minimum) network distance from b . Similarly $s \leq_b t$ if the network distance from t to b is greater than the network distance of s from b .

- We terminate this procedure as soon as b_e is covered by $\cup_{i=1}^l [s_i^e t_i^e]$, and set $\mathbf{L}_\Gamma(e) = \{s_1^e t_1^e, \dots, s_l^e t_l^e\}$.

Next we define

$$\mathbf{L}_\Gamma = \bigcup_{e \in F} \mathbf{L}_\Gamma(e).$$

Given a lace $L \in \mathcal{L}(\mathcal{S})$ we define

$$\mathcal{C}(L) = \{st \in \mathbf{E}_\mathcal{S} \setminus L : \mathbf{L}_{L \cup st} = L\} \tag{2.2}$$

to be the set of bonds *compatible* with L . In particular if $L \in \mathcal{L}(\mathcal{S})$ and if there is a bond $s't' \in L$ (with $s't' \neq st$) which covers both s and t (i.e. $[s, t] \subsetneq [s't']$), then st is compatible with L .

The following results (with only small modifications required for the different notion of connectivity) are proved for star-shaped networks in [19].

Lemma 2.5. *Given a star shaped network $\mathcal{S} = \mathcal{S}_n^\Delta$, $\Delta \in \{1, 3\}$, and a connected graph $\Gamma \in \mathcal{G}^{con}(\mathcal{S})$, the graph \mathbf{L}_Γ is a lace on \mathcal{S} .*

Lemma 2.6. *Let $\Gamma \in \mathcal{G}_\mathcal{S}^{-\mathcal{R}, con}$. Then $\mathbf{L}_\Gamma = L$ if and only if $L \subseteq \Gamma$ is a lace and $\Gamma \setminus L \subseteq \mathcal{C}(L)$.*

See Figure 8 for an example of a connected graph Γ on a star-shaped network of degree 3, and its corresponding lace \mathbf{L}_Γ .

2.2 Classification of laces

Definition 2.7 (Minimal lace). *We write $\mathcal{L}_{min}(\mathcal{S})$ for the set of minimal laces on \mathcal{S} .*

A lace L on a star shape \mathcal{S} of degree 1 (or equivalently 2) is necessarily minimal by Definitions 2.3 and 2.1. For a lace on a star shape of degree 3 this need not be true. See Figure 9 for an example of a minimal and a non-minimal lace for $\Delta = 3$. A non-minimal lace contains a bond st that is “removable” in the sense that $L \setminus \{st\}$ is still a lace. In general such a bond is not unique. One can easily construct a lace on a star shaped network of degree 3 for which each of the bonds $s_1 t_1, \dots, s_3 t_3$ covering the branch point satisfy $L \setminus \{s_i t_i\} \in \mathcal{L}(\mathcal{S})$.

Definition 2.8 (Acyclic). *A lace L on \mathcal{S}^3 is acyclic if there is at least one branch \mathcal{S}_e (called a special branch) such that there is exactly one bond, st in L , covering the branch point of \mathcal{S}^3 that has an endpoint strictly on branch \mathcal{S}_e . A lace that is not acyclic is called cyclic.*

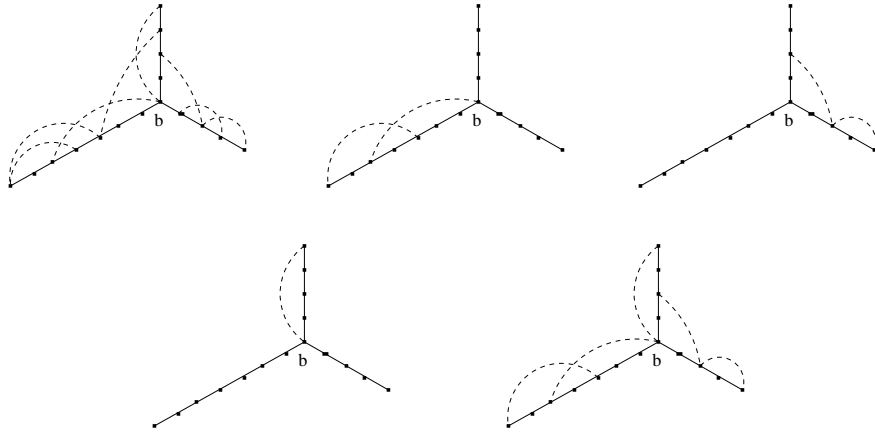

Figure 8: An illustration of the construction of a lace from a connected graph. The first figure shows a connected graph Γ on a star $S^3_{(n_1, n_2, n_3)}$. The intermediate figures show each of the $\mathbf{L}_\Gamma(e)$ for $e \in F_b$, while the last figure shows the lace \mathbf{L}_Γ .

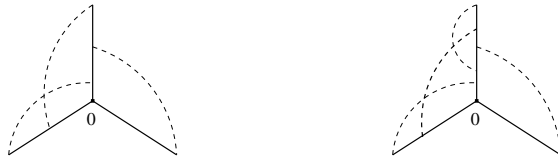

Figure 9: Basic examples of a minimal and a non-minimal lace for $\Delta = 3$. For the non-minimal lace, a “removable” edge is highlighted.

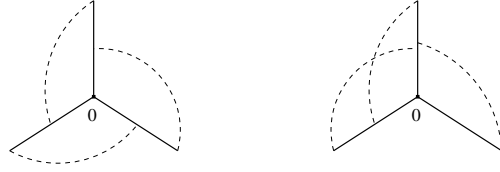

Figure 10: Basic examples of a cyclic and an acyclic lace.

It is obvious that in the above definition, st is the bond in L associated to branch \mathcal{S}_e . In addition, it is immediate from Definition 2.8 that for a cyclic lace, the bonds covering the branch point can be ordered as $\{s_k t_k : k = 1, \dots, 3\}$, with t_k and s_{k+1} on the same branch for each k (with s_4 identified with s_1). See Figure 10 for an example of this classification.

Let $\mathcal{L}^{e,N}(\mathcal{S})$ be the set of laces $L \in \mathcal{L}^N(\mathcal{S})$, such that $L \setminus \{s^e t^e\} \in \mathcal{L}^{N-1}(\mathcal{S})$, where $s^e t^e$ is the bond in L associated to \mathcal{S}_e . Let

$$\mathcal{L}_{min}^{e,N-1} = \{L \in \mathcal{L}_{min}^{N-1}(\mathcal{S}) : \exists st \text{ with } L \cup \{st\} \in \mathcal{L}^{e,N}(\mathcal{S}), st \text{ associated to } \mathcal{S}_e \text{ for } L \cup \{st\}\}, \quad (2.3)$$

and observe that $\mathcal{L}_{min}^{e,N-1}$ is a subset of the (acyclic) laces with two bonds covering the branch point. Given $L \in \mathcal{L}_{min}^{e,N-1}$, define

$$\mathcal{P}^e(L) = \{st : L \cup \{st\} \in \mathcal{L}^{e,N}(\mathcal{S}), st \text{ associated to } \mathcal{S}_e \text{ for } L \cup \{st\}\}. \quad (2.4)$$

Using $\dot{\cup}$ to denote a disjoint union, as shown in [19],

$$\mathcal{L}^{e,N}(\mathcal{S}) \subseteq \dot{\cup}_{L \in \mathcal{L}_{min}^{e,N-1}(\mathcal{S})} \dot{\cup}_{st \in \mathcal{P}^e(L)} \{L \cup \{st\}\}. \quad (2.5)$$

The set $\mathcal{P}^e(L)$ can be totally ordered firstly according to distances from the branch point and then by branch numbers. The following Lemma is proved in [19].

Lemma 2.9 ([19], Lemma 6.4). *Given a lace $L \in \mathcal{L}_{min}^{e,N-1}$ and $st \in \mathcal{P}^e(L)$,*

$$\mathcal{C}(L \cup \{st\}) = \mathcal{C}(L) \dot{\cup} \{ij \in \mathcal{P}^e(L) : ij < st\}. \quad (2.6)$$

2.3 The Expansion

Here we examine products of the form $\prod_{st \in \mathbf{E}_{\mathcal{N}}} [1 + U_{st}]$. Following the method of [20], we write

$$\prod_{st \in \mathbf{E}_{\mathcal{N}}} [1 + U_{st}] = \prod_{st \in \mathbf{E}_{\mathcal{N}} \setminus \mathcal{R}} [1 + U_{st}] - \left(\prod_{st \in \mathbf{E}_{\mathcal{N}} \setminus \mathcal{R}} [1 + U_{st}] \right) \left(1 - \prod_{st \in \mathcal{R}} [1 + U_{st}] \right). \quad (2.7)$$

Define $K(\mathcal{M}) = \prod_{st \in \mathbf{E}_{\mathcal{M}} \setminus \mathcal{R}} [1 + U_{st}]$. Expanding this we obtain, for each possible subset of $\mathbf{E}_{\mathcal{M}} \setminus \mathcal{R}$, a product of U_{st} for st in that subset. The subsets of $\mathbf{E}_{\mathcal{M}} \setminus \mathcal{R}$ are precisely the graphs on \mathcal{M} which contain no elements of \mathcal{R} , hence

$$K(\mathcal{M}) = \sum_{\Gamma \in \mathcal{G}_{\mathcal{M}}^{-\mathcal{R}}} \prod_{st \in \Gamma} U_{st}, \quad (2.8)$$

where the empty product $\prod_{st \in \emptyset} U_{st} = 1$ by convention. Similarly we define

$$J(\mathcal{M}) = \sum_{\Gamma \in \mathcal{G}_N^{-\mathcal{R}, \text{con}}} \prod_{st \in \Gamma} U_{st}. \quad (2.9)$$

If \mathcal{M} is a single vertex then $J(\mathcal{M}) = 1$. If \mathcal{S} is a star-shaped network of degree 1 or 3 then

$$\begin{aligned} J(\mathcal{S}) &= \sum_{L \in \mathcal{L}(\mathcal{S})} \sum_{\substack{\Gamma \in \mathcal{G}_S^{\text{con}}: \\ \mathbf{L}_\Gamma = L}} \prod_{st \in \Gamma} U_{st} = \sum_{L \in \mathcal{L}(\mathcal{S})} \prod_{st \in L} U_{st} \sum_{\substack{\Gamma \in \mathcal{G}_S^{\text{con}}: \\ \mathbf{L}_\Gamma = L}} \prod_{s't' \in \Gamma \setminus L} U_{s't'} \\ &= \sum_{L \in \mathcal{L}(\mathcal{S})} \prod_{st \in L} U_{st} \sum_{\Gamma' \subset \mathcal{C}(L)} \prod_{s't' \in \Gamma'} U_{s't'} = \sum_{N=1}^{\infty} \sum_{L \in \mathcal{L}^N(\mathcal{S})} \prod_{st \in L} U_{st} \prod_{s't' \in \mathcal{C}(L)} [1 + U_{s't'}], \end{aligned} \quad (2.10)$$

where the second to last equality holds since for fixed L , $\{\Gamma \in \mathcal{G}_S^{\text{con}} : \mathbf{L}_\Gamma = L\} = \{L \cup \Gamma' : \Gamma' \subseteq \mathcal{C}(L)\}$ by Lemma 2.6. The last equality holds as in the discussion preceding (2.8) since expanding $\prod_{s't' \in \mathcal{C}(L)} [1 + U_{s't'}]$ we obtain for each possible subset of $\mathcal{C}(L)$, a product of U_{st} for st in that subset.

In Section 4 we will have $U_{st} \in \{-1, 0\}$ whence

$$|J(\mathcal{S})| \leq \sum_{L \in \mathcal{L}(\mathcal{S})} \prod_{st \in L} -U_{st} \sum_{s't' \in \mathcal{C}(L)} [1 + U_{s't'}]. \quad (2.11)$$

We use (2.5) and (2.6) to bound the contribution to (2.11) from non-minimal laces (containing $N \geq 3$ bonds) as follows,

$$\begin{aligned} \sum_{L \in \mathcal{L}^{e, N}(\mathcal{S})} \prod_{st \in L} -U_{st} \prod_{s't' \in \mathcal{C}(L)} [1 + U_{s't'}] &\leq \sum_{L \in \mathcal{L}_{\min}^{e, N-1}(\mathcal{S})} \prod_{st \in L} -U_{st} \sum_{ij \in \mathcal{P}^e(L)} -U_{ij} \prod_{s't' \in \mathcal{C}(L \cup \{ij\})} [1 + U_{s't'}] \\ &\leq \sum_{L \in \mathcal{L}_{\min}^{e, N-1}(\mathcal{S})} \prod_{st \in L} -U_{st} \prod_{s't' \in \mathcal{C}(L)} [1 + U_{s't'}] \sum_{ij \in \mathcal{P}^e(L)} -U_{ij} \prod_{\substack{i'j' \in \mathcal{P}^e(L): \\ i'j' < ij}} [1 + U_{i'j'}]. \end{aligned} \quad (2.12)$$

Now using the fact (e.g. see [19]) that

$$0 \leq \sum_{ij \in \mathcal{P}^e(L)} -U_{ij} \prod_{i'j' \in \mathcal{P}^e(L): i'j' < ij} [1 + U_{i'j'}] = 1 - \prod_{st \in \mathcal{P}^e(L)} [1 + U_{st}] \leq 1, \quad (2.13)$$

the last line of (2.12) is bounded by

$$\sum_{L \in \mathcal{L}_{\min}^{e, N-1}(\mathcal{S})} \prod_{st \in L} -U_{st} \prod_{s't' \in \mathcal{C}(L)} [1 + U_{s't'}].$$

Summing over $e \in \{1, 2, 3\}$, we see that the contribution to (2.11) from non-minimal laces containing N bonds is bounded by 3 times the contribution from minimal laces containing $N - 1$ bonds. This will be important as we will only need to bound the diagrams arising from minimal laces in Section 4.

2.3.1 Recursion type expression for $K(\mathcal{N})$

Recall that $\mathcal{N} = \mathcal{N}(\alpha, \vec{n})$ where $\alpha \in \Sigma_r$ and $\vec{n} \in \mathbb{N}^{2r-3}$, for some $r \geq 2$. If $r = 2$ then let b be the root of \mathcal{N} . Otherwise let b be the branch point neighbouring the root of \mathcal{N} . In each case let $\mathcal{S}_{\mathcal{N}}^-$ be the largest connected subnetwork of \mathcal{N} containing b and no vertices that are adjacent to any other branch points of \mathcal{N} ($\mathcal{S}_{\mathcal{N}}^-$ could be empty or a single vertex). Observe that for any graph $\Gamma \in \mathcal{G}_{\mathcal{N}}^{-\mathcal{R}} \setminus \mathcal{E}_{\mathcal{N}}^b$, the subnetwork $\mathcal{A}_b(\Gamma)$ contains no branch point of \mathcal{N} other than b (if $r \geq 3$) and hence is a star shape of degree 0, 1 or 3.

Definition 2.10. *If \mathcal{M} is a connected subnetwork of \mathcal{N} then we define $\mathcal{N} \setminus \mathcal{M}$ to be the set of vertices of \mathcal{N} that are not in \mathcal{M} together with the edges of \mathcal{N} connecting them. In general $(\mathcal{N} \setminus \mathcal{M}) \cup \mathcal{M}$ contains fewer edges than \mathcal{N} , and $\mathcal{N} \setminus \mathcal{M}$ need not be connected. However if $\mathcal{M} \subset \mathcal{S}_{\mathcal{N}}^-$ then $\mathcal{N} \setminus \mathcal{M}$ has at most 3 connected components (at most 1 if $r = 2$) and we write $(\mathcal{N} \setminus \mathcal{M})_i$, $i = 1, 2, 3$ for these components, where we allow $(\mathcal{N} \setminus \mathcal{M})_i = \emptyset$.*

Definition 2.10 allows us to write

$$\begin{aligned} K(\mathcal{N}) &= \sum_{\Gamma \in \mathcal{G}_{\mathcal{N}}^{-\mathcal{R}} \setminus \mathcal{E}_{\mathcal{N}}^b} \prod_{st \in \Gamma} U_{st} + \sum_{\Gamma \in \mathcal{E}_{\mathcal{N}}^b} \prod_{st \in \Gamma} U_{st} \\ &= \sum_{\substack{\mathcal{A} \subset \mathcal{S}_{\mathcal{N}}^- \\ b \in \mathcal{A}}} \sum_{\Gamma \in \mathcal{G}_{\mathcal{A}}^{con}} \prod_{st \in \Gamma} U_{st} \prod_{i=1}^3 \sum_{\Gamma_i \in \mathcal{G}_{(\mathcal{N} \setminus \mathcal{A})_i}^{-\mathcal{R}}} \prod_{s^i t^i \in \Gamma_i} U_{s^i t^i} + \sum_{\Gamma \in \mathcal{E}_{\mathcal{N}}^b} \prod_{st \in \Gamma} U_{st}, \end{aligned} \quad (2.14)$$

where the sum over \mathcal{A} is a sum over connected subnetworks of \mathcal{N} containing b and no vertices adjacent to any other branch points of \mathcal{N} . Some of the $(\mathcal{N} \setminus \mathcal{A})_i$ may be a single vertex or empty and we define $\sum_{\Gamma_i \in \mathcal{G}_0} \prod_{s^i t^i \in \Gamma_i} U_{s^i t^i} = 1$. Defining $E^{(b)}(\mathcal{N}) = \sum_{\Gamma \in \mathcal{E}_{\mathcal{N}}^b} \prod_{st \in \Gamma} U_{st}$, we have

$$K(\mathcal{N}) = \sum_{\substack{\mathcal{A} \subset \mathcal{S}_{\mathcal{N}}^- \\ b \in \mathcal{A}}} J(\mathcal{A}) \prod_{i=1}^3 K((\mathcal{N} \setminus \mathcal{A})_i) + E^{(b)}(\mathcal{N}). \quad (2.15)$$

Depending on \mathcal{N} , the first term of (2.15) may be zero since $\mathcal{S}_{\mathcal{N}}^-$ may be empty. The fact that for any \mathcal{A} contributing to this first term, the subtrees $(\mathcal{N} \setminus \mathcal{A})_i$ are of degree $r_i < r$ is what allows for an inductive proof of Theorem 1.14.

If $r = 2$ then \mathcal{N} contains no branch point. In this case we may identify the star-shaped network $\mathcal{S}^1(m)$ with the interval $[0, m]$ and (2.14)-(2.15) reduce to

$$K([0, n]) = \sum_{m \leq n} J([0, m])K([m+1, n]), \quad (2.16)$$

which is the usual relation for the expansion of $K(\cdot)$ on an interval for this notion of connectivity (see for example [8]). Otherwise b is a branch point of \mathcal{N} and we let $K(\emptyset) \equiv 1$, and $I_i = I_i(\mathcal{N})$ be the indicator function that the branch i is incident to b and another branch point b_i . Therefore for a fixed network \mathcal{N} such that $\mathcal{S}_{\mathcal{N}}^-$ is nonempty, $n_i - 2I_2 = n_i - 2I_2(\mathcal{N})$ is equal to either $n_2 - 2$ (if branch 2 is incident to b and another branch point b_i) or n_i . Then (2.14)-(2.15) give

$$K(\mathcal{N}) = \sum_{m_1 \leq n_1} \sum_{\substack{m_2 \leq n_2 - 2I_2 \\ m_3 \leq n_3 - 2I_3}} J(\mathcal{S}_{\vec{m}}) \prod_{i=1}^3 K((\mathcal{N} \setminus \mathcal{S}_{\vec{m}})_i) + E^{(b)}(\mathcal{N}), \quad (2.17)$$

where $\mathcal{S}_{\vec{m}}$ is a star-shaped network satisfying

$$\mathcal{S}_{\vec{m}} = \begin{cases} \{b\} & \text{if } \vec{m} = \vec{0}, \\ \mathcal{S}_{\vec{m}}^3 & \text{if } m_i \neq 0 \text{ for all } i, \\ \mathcal{S}[0, m_i] & \text{if } m_i \neq 0 \text{ and } m_j = 0 \text{ for } j \neq i, \\ \mathcal{S}[-m_j, m_i] & \text{if } j > i, m_j \neq 0, m_i \neq 0, \text{ and } m_k = 0 \text{ for } k \neq i, j. \end{cases} \quad (2.18)$$

In the case where there is another branch point b_e that is adjacent to b in \mathcal{N} (so that n_2 or n_3 is 1), the sum over at least one of m_2, m_3 in (2.17) is empty. However note that this case contributes to the term $E^{(b)}(\mathcal{N})$, as required.

3 The 2-point function

In this section we prove Theorem 1.12 using an extension of the inductive approach to the lace expansion of [17]. The extension of the induction approach is described and proved in a general setting in [15]. Broadly speaking there are two main ingredients involved in applying the results of [15]. Firstly we must obtain a *recursion relation* for the quantity of interest, the Fourier transform of the 2-point function, and massage this relation so that it takes the form (1.6), with each f_i, g_i having continuous second derivative in a neighbourhood of 0 and $f_0(k; z) = 1, f_1(k; z) = z\widehat{D}(k), e_1(k; z) = 0$. Secondly we must verify the hypotheses that certain bounds on the quantities f_m for $1 \leq m \leq n$ appearing in (1.6) imply further bounds on the quantities g_m, e_m , for $2 \leq m \leq n + 1$. This second ingredient consists of reducing the bounds required to diagrammatic estimates, and then estimating the relevant diagrams.

In Section 3.1 we prove a recursion relation of the form (1.6) for a quantity closely related to the Fourier transform of the 2-point function. In Section 3.2 we state the assumptions of the inductive approach for a specific choice of parameters corresponding to our particular model. In Section 3.3 we reduce the verification of these assumptions to proving a single result, Proposition 3.6. Assuming Proposition 3.6, the induction approach then yields Theorem 3.7, which we show in Section 3.4 implies Theorem 1.12. The diagrammatic estimates involved in proving Proposition 3.6 provide the most model dependent aspect of the analysis and these are postponed until Section 5.

3.1 Recursion relation for the 2-point function

Recall Definitions 1.4, 1.6, and 1.8. Also recall from Definition 1.10 that the two point function is defined as

$$t_n(x; \zeta) = \zeta^n \sum_{T \in \mathcal{T}_n(x)} W(T).$$

Now $T \in \mathcal{T}_n(x)$ if and only if T is the union (as a set of vertices and edges) of an n -step (self-avoiding) walk ω from o to x together with a collection of mutually avoiding branches $R_i \in \mathcal{T}(\omega(i)), i = 0, 1, \dots, n$ (see Figure 11). Let

$$U_{st} = U(R_s, R_t) = \begin{cases} -1, & \text{if } R_s \cap R_t \neq \emptyset \\ 0, & \text{otherwise.} \end{cases} \quad (3.1)$$

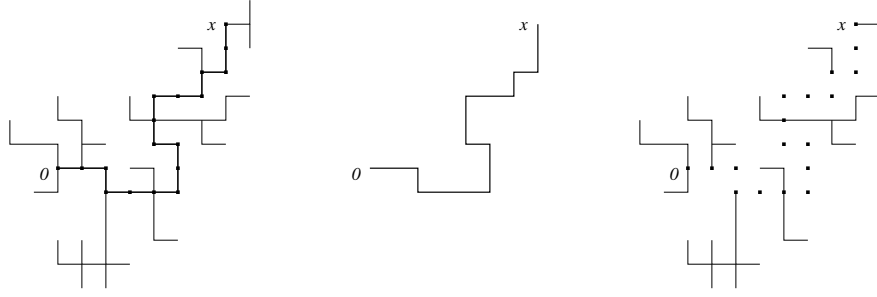

Figure 11: The first figure is of a lattice tree $T \in \mathcal{T}_n(x)$ for $n = 17$. The second figure shows the backbone ω , while the third shows the mutually avoiding lattice trees R_0, \dots, R_n emanating from the backbone.

Then $\prod_{0 \leq s < t \leq n} [1 + U_{st}]$ is the indicator function that all the R_i avoid each other. Summarising the above discussion and using the fact that the weight $W(T)$ of a tree factorises into (bond) disjoint components (see Definition 1.7) we can write,

$$t_n(x; \zeta) = \zeta^n \sum_{\substack{\omega: o \rightarrow x, \\ |\omega|=n}} W(\omega) \sum_{R_0 \in \mathcal{T}(\omega(0))} W(R_0) \sum_{R_1 \in \mathcal{T}(\omega(1))} W(R_1) \cdots \sum_{R_n \in \mathcal{T}(\omega(n))} W(R_n) \prod_{0 \leq s < t \leq n} [1 + U_{st}], \quad (3.2)$$

where the first sum is over *random walk paths* of length n from 0 to x . To simplify this expression, we abuse notation and replace (3.2) with

$$t_n(x; \zeta) = \zeta^n \sum_{\substack{\omega: o \rightarrow x, \\ |\omega|=n}} W(\omega) \prod_{i=0}^n \sum_{R_i \in \mathcal{T}(\omega(i))} W(R_i) \prod_{0 \leq s < t \leq n} [1 + U_{st}]. \quad (3.3)$$

Recall Definition 2.1 and the discussion following it. The set of vertices $[0, n]$ corresponds to the set of vertices of $\mathcal{N}(\alpha, n)$, where α is the unique shape in Σ_2 . Since this \mathcal{N} contains no branch points, we have $\mathcal{R} = \emptyset$ and therefore from Section 2.3 we have $\prod_{0 \leq s < t \leq n} [1 + U_{st}] = K(\mathcal{N}) = K([0, n])$. Hence

$$t_n(x; \zeta) = \zeta^n \sum_{\substack{\omega: o \rightarrow x \\ |\omega|=n}} W(\omega) \prod_{i=0}^n \sum_{R_i \in \mathcal{T}(\omega(i))} W(R_i) K([0, n]). \quad (3.4)$$

Definition 3.1. For $m \geq 0$ we define

$$\pi_m(x; \zeta) = \zeta^m \sum_{\substack{\omega: o \rightarrow x \\ |\omega|=m}} W(\omega) \prod_{i=0}^m \sum_{R_i \in \mathcal{T}(\omega(i))} W(R_i) J([0, m]). \quad (3.5)$$

Note that for $m = 0$ this is simply $\sum_{R_0 \in \mathcal{T}(0)} W(R_0) = \rho(o)$, if $x = 0$, and zero otherwise.

Definition 3.2. The convolution of functions f_i , $i = 1, \dots, n$ is defined as the function

$$(f_1 * f_2 * \cdots * f_n)(x) = \sum_{y_1 \in \mathbb{Z}^d} \sum_{y_2 \in \mathbb{Z}^d} \cdots \sum_{y_{n-1} \in \mathbb{Z}^d} f_1(y_1) \prod_{i=2}^{n-1} f_i(y_i - y_{i-1}) f_n(x - y_{n-1}),$$

at all points x where this converges.

We often write $f^{(n)}(x)$ for the n -fold convolution convolution of f with itself, e.g. $f^{(2)}(x) = (f * f)(x)$.

The following recursion relation is the starting point for obtaining a relation of the form (1.6).

Proposition 3.3. For $x \in \mathbb{Z}^d$,

$$t_{n+1}(x; \zeta) = \sum_{m=1}^n (\pi_m * \zeta p_c D * t_{n-m})(x; \zeta) + \pi_{n+1}(x; \zeta) + \rho(o)(\zeta p_c D * t_n)(x; \zeta). \quad (3.6)$$

Proof. Firstly recall that t_n and D have finite range. Similarly, the bound (2.11) and the fact that there are only finitely many laces on $\mathcal{S}([0, n])$ for each n shows that $|\pi_m(x; \zeta)| \leq c_m \zeta^m D^{(m)}(x)$ for some c_n depending on n but not x . In particular each $\pi_m(x; \zeta)$ also has finite range and therefore all of the convolutions in (3.6) exist for all x .

By definition

$$t_{n+1}(x; \zeta) = \zeta^{n+1} \sum_{\substack{\omega: o \rightarrow x, \\ |\omega|=n+1}} W(\omega) \prod_{i=0}^{n+1} \sum_{R_i \in \mathcal{T}(\omega(i))} W(R_i) K([0, n+1]). \quad (3.7)$$

Equation (2.16) gives

$$K([0, n+1]) = K([1, n+1]) + \sum_{m=1}^n J([0, m]) K([m+1, n+1]) + J([0, n+1]). \quad (3.8)$$

Putting this expression into equation (3.7) gives rise to three terms which we consider separately.

1. The contribution from graphs for which 0 is not covered by any bond: We break the backbone from 0 to x (a walk of length $n+1$) into a single step walk and the remaining n -step walk as follows.

$$\begin{aligned} & \zeta^{n+1} \sum_{\substack{\omega: o \rightarrow x, \\ |\omega|=n+1}} W(\omega) \prod_{i=0}^{n+1} \sum_{R_i \in \mathcal{T}(\omega(i))} W(R_i) K[1, n+1] \\ &= \sum_{R_0 \in \mathcal{T}(o)} W(R_0) \sum_{y \in \Omega_D} \sum_{\substack{\omega_1: o \rightarrow y, \\ |\omega_1|=1}} \zeta W(\omega_1) \sum_{\substack{\omega_2: y \rightarrow x, \\ |\omega_2|=n}} \zeta^n W(\omega_2) \prod_{i=1}^{n+1} \sum_{R_i \in \mathcal{T}(\omega_2(i-1))} W(R_i) K([1, n+1]), \end{aligned} \quad (3.9)$$

where $K[1, n+1]$ depends on R_1, \dots, R_{n+1} but not R_0 . Therefore using the substitutions $R'_j = R_{j+1}$ this is equal to

$$\begin{aligned} & \rho(o) \sum_{y \in \Omega_D} \sum_{\substack{\omega_1: o \rightarrow y, \\ |\omega_1|=1}} \zeta W(\omega_1) \sum_{\substack{\omega_2: y \rightarrow x, \\ |\omega_2|=n}} \zeta^n W(\omega_2) \prod_{j=0}^n \sum_{R'_j \in \mathcal{T}(\omega_2(j))} W(R'_j) K([0, n]) \\ &= \rho(o) \sum_{y \in \Omega_D} p_c \zeta D(y) t_n(x-y; \zeta) = \rho(o) p_c \zeta (D * t_n)(x). \end{aligned} \quad (3.10)$$

2. The contribution from graphs which are connected on $[0, n + 1]$:

$$\zeta^{n+1} \sum_{\substack{\omega: o \rightarrow x, \\ |\omega|=n+1}} W(\omega) \prod_{i=0}^{n+1} \sum_{R_i \in \mathcal{T}(\omega(i))} W(R_i) J([0, n + 1]) = \pi_{n+1}(x; \zeta) \quad (3.11)$$

3. The contribution from graphs which are connected on $[0, m]$ for some $m \in \{1, \dots, n\}$: We break the backbone from 0 to x (a walk of length $n + 1$) up into three walks, of lengths m , 1 and $n - m$ respectively

$$\begin{aligned} & \zeta^{n+1} \sum_{\substack{\omega: o \rightarrow x, \\ |\omega|=n+1}} W(\omega) \prod_{i=0}^{n+1} \sum_{R_i \in \mathcal{T}(\omega(i))} W(R_i) \sum_{m=1}^n J[0, m] K[m + 1, n + 1] \\ &= \sum_{m=1}^n \sum_u \sum_v \sum_{\substack{\omega_1: o \rightarrow u, \\ |\omega_1|=m}} \zeta^m W(\omega_1) \left(\prod_{i=0}^m \sum_{R_i \in \mathcal{T}(\omega_1(i))} W(R_i) \right) J[0, m] \left[\sum_{\substack{\omega_2: u \rightarrow v, \\ |\omega_2|=1}} \zeta W(\omega_2) \right] \times \\ & \quad \sum_{\substack{\omega_3: v \rightarrow x \\ |\omega_3|=n-m}} \zeta^{n-m} W(\omega_3) \left(\prod_{i=m+1}^{n+1} \sum_{R_i \in \mathcal{T}(\omega_3(i-(m+1)))} W(R_i) \right) K[m + 1, n + 1]. \end{aligned} \quad (3.12)$$

Now $[0, m]$ and $[m + 1, n + 1]$ are disjoint, so $J([0, m])$ and $K([m + 1, n + 1])$ contain information about disjoint subsets of $\{R_i : i \in \{0, \dots, n + 1\}\}$. Using the substitutions $R'_j = R_{j+m+1}$ this is equal to:

$$\begin{aligned} & \sum_{m=1}^n \sum_u \sum_v \sum_{\substack{\omega_1: o \rightarrow u, \\ |\omega_1|=m}} \zeta^m W(\omega_1) \left(\prod_{i=0}^m \sum_{R_i \in \mathcal{T}(\omega_1(i))} W(R_i) \right) J[0, m] \times \\ & p_c \zeta D(v - u) \sum_{\substack{\omega_3: v \rightarrow x \\ |\omega_3|=n-m}} \zeta^{n-m} W(\omega_3) \left(\prod_{j=0}^{n-m} \sum_{R'_j \in \mathcal{T}(\omega_3(j))} W(R'_j) \right) K[0, n - m] \quad (3.13) \\ &= \sum_{m=1}^n \sum_u \sum_v \pi_m(u; \zeta) p_c \zeta D(v - u) t_{n-m}(x - v; \zeta) = \sum_{m=1}^n (\pi_m * p_c \zeta D * t_{n-m})(x; \zeta). \end{aligned}$$

□

Dividing both sides of (3.6) by $\rho(o)$ and taking Fourier transforms, we get

$$\frac{\widehat{t}_{n+1}(k; \zeta)}{\rho(o)} = \sum_{m=1}^n \frac{\widehat{\pi}_m(k; \zeta)}{\rho(o)} \rho(o) \zeta p_c \widehat{D}(k) \frac{\widehat{t}_{n-m}(k; \zeta)}{\rho(o)} + \frac{\widehat{\pi}_{n+1}(k; \zeta)}{\rho(o)} + \rho(o) \zeta p_c \widehat{D}(k) \frac{\widehat{t}_n(k; \zeta)}{\rho(o)}. \quad (3.14)$$

Definition 3.4. For fixed $\zeta \geq 0$, define

$$1) \quad z = \rho(o) \zeta p_c.$$

2) $f_0(k; z) = 1$, $f_1(k; z) = g_1(k; z) = z\widehat{D}(k)$, and $e_1(k; z) = 0$.

3) For $n \geq 2$,

$$\begin{aligned} f_n(k; z) &= \frac{\widehat{t}_n(k; \zeta)}{\rho(o)}, & g_n(k; z) &= \frac{\widehat{\pi}_{n-1}(k; \zeta)}{\rho(o)} z\widehat{D}(k) \\ e_n(k; z) &= g_{n-1}(k; z) \left[\frac{\widehat{t}_1(k; \zeta)}{\rho(o)} - z\widehat{D}(k) \right] + \frac{\widehat{\pi}_n(k; \zeta)}{\rho(o)}. \end{aligned} \quad (3.15)$$

We note from (3.14) with $n = 0$ that since $t_0(x) = \rho(o)I_{x=0}$, we have $\widehat{t}_0(k) = \rho(o)$ and

$$\frac{\widehat{t}_1(k; \zeta)}{\rho(o)} - z\widehat{D}(k) = \frac{\widehat{\pi}_1(k; \zeta)}{\rho(o)}. \quad (3.16)$$

Therefore for $n \geq 2$

$$e_n(k; z) = g_{n-1}(k; z) \frac{\widehat{\pi}_1(k; \zeta)}{\rho(o)} + \frac{\widehat{\pi}_n(k; \zeta)}{\rho(o)}. \quad (3.17)$$

For $n \geq 3$ this is

$$e_n(k; z) = \frac{\widehat{\pi}_{n-2}(k; \zeta)}{\rho(o)} z\widehat{D}(k) \frac{\widehat{\pi}_1(k; \zeta)}{\rho(o)} + \frac{\widehat{\pi}_n(k; \zeta)}{\rho(o)}.$$

Lemma 3.5. *The choices of f_m, g_m, e_m above satisfy (1.6).*

Proof. This is an easy exercise using (3.14).

3.2 Assumptions of the induction method

The induction approach to the lace expansion of [17] is extended in [15] with the introduction of two parameters θ and p^* and a set $B \subset [1, p^*]$. In this section we apply the extension with the choices $\theta = \frac{d-4}{2}$, $p^* = 2$, $B = \{2\}$ and we define $\beta = L^{-\frac{d}{p^*}} = L^{-\frac{d}{2}}$. We have already shown in Section 3.1 that for our choices of f_m, g_m, e_m as given in Definition 3.4,

$$f_{n+1}(k; z) = \sum_{m=1}^{n+1} g_m(k; z) f_{n+1-m}(k; z) + e_{n+1}(k; z) \quad (n \geq 0),$$

with $f_0(k; z) = 1$. The assumptions of [15] in our lattice trees setting are as follows.

Assumption S. For every $n \in \mathbb{N}$ and $z > 0$, the mapping $k \mapsto f_n(k; z)$ is symmetric under replacement of any component k_i of k by $-k_i$, and under permutations of the components of k . The same holds for $e_n(\cdot; z)$ and $g_n(\cdot; z)$. In addition, for each n , $|f_n(k; z)|$ is bounded uniformly in $k \in [-\pi, \pi]^d$ and z in a neighbourhood of 1 (which may depend on n). The functions f_n and g_n have continuous second derivatives with respect to k in a neighbourhood of 0 for every n .

Assumption D. As part of Assumption D, we assume that:

(i) D is normalised so that $\widehat{D}(0) = 1$, and has $2 + 2\epsilon$ moments for some $\epsilon \in (0, 1 \wedge \frac{d-8}{2})$, i.e.,

$$\sum_{x \in \mathbb{Z}^d} |x|^{2+2\epsilon} D(x) < \infty. \quad (3.18)$$

(ii) There is a constant C such that, for all $L \geq 1$,

$$\|D\|_\infty \leq CL^{-d}, \quad \sigma^2 = \sigma_L^2 \leq CL^2, \quad (3.19)$$

(iii) Define $a(k) = 1 - \hat{D}(k)$. There exist constants $\eta, c_1, c_2 > 0$ such that

$$c_1 L^2 |k|^2 \leq a(k) \leq c_2 L^2 |k|^2 \quad (\|k\|_\infty \leq L^{-1}), \quad (3.20)$$

$$a(k) > \eta \quad (\|k\|_\infty \geq L^{-1}), \quad (3.21)$$

$$a(k) < 2 - \eta \quad (k \in [-\pi, \pi]^d). \quad (3.22)$$

For $h : [-\pi, \pi]^d \rightarrow \mathbb{C}$, we define

$$\nabla^2 h(k_0) = \left. \sum_{j=1}^d \frac{\partial^2}{\partial k_j^2} h(k) \right]_{k=k_0}. \quad (3.23)$$

The relevant bounds on f_m , which *a priori* may or may not be satisfied, are that

$$\|\hat{D}^2 f_m(\cdot; z)\|_2 \leq \frac{K}{L^{\frac{d}{2}} m^{\frac{d}{4}}}, \quad |f_m(0; z)| \leq K, \quad |\nabla^2 f_m(0; z)| \leq K \sigma^2 m, \quad (3.24)$$

for some positive constant K . Recall that

$$\beta = L^{-\frac{d}{2}}. \quad (3.25)$$

Assumption E. There is an interval $I \subset [1 - \alpha, 1 + \alpha]$ with $\alpha \in (0, 1)$, and a function $K \mapsto C_e(K)$, such that: if (3.24) holds for some $K, L \geq 1$, $z \in I$ and all m with $1 \leq m \leq n$, then for this K , L and z , and for all $k \in [-\pi, \pi]^d$ and $2 \leq m \leq n + 1$, the following bounds hold:

$$|e_m(k; z)| \leq C_e(K) \beta m^{-\frac{d-4}{2}}, \quad |e_m(k; z) - e_m(0; z)| \leq C_e(K) a(k) \beta m^{-\frac{d-6}{2}}.$$

Assumption G. There is an interval $I \subset [1 - \alpha, 1 + \alpha]$ with $\alpha \in (0, 1)$, and a function $K \mapsto C_g(K)$, such that: if (3.24) holds for some $K, L \geq 1$, $z \in I$ and all m with $1 \leq m \leq n$, then for this K , L and z , and for all $k \in [-\pi, \pi]^d$ and $2 \leq m \leq n + 1$, the following bounds hold:

$$|g_m(k; z)| \leq C_g(K) \beta m^{-\frac{d-4}{2}}, \quad |\nabla^2 g_m(0; z)| \leq C_g(K) \sigma^2 \beta m^{-\frac{d-6}{2}},$$

$$|\partial_z g_m(0; z)| \leq C_g(K) \beta m^{-\frac{d-6}{2}},$$

$$|g_m(k; z) - g_m(0; z) - a(k) \sigma^{-2} \nabla^2 g_m(0; z)| \leq C_g(K) \beta a(k)^{1+\epsilon'} m^{-\frac{d-6}{2} + \epsilon'},$$

with the last bound valid for any $\epsilon' \in [0, \epsilon)$.

3.3 Verifying assumptions

Assumption S: The quantities $f_n(k; z)$, $n = 0, 1, \dots$ are (up to constants) the Fourier transforms of $t_n(x, \zeta)$, and hence have all required symmetries since \widehat{D} does. Similarly the π_m are symmetric, so that the quantities g_n, e_n also have the required symmetries. Now $f_0 = 1$ is trivially uniformly bounded in k and $z \leq 2$. Recall that $\sum_x t_n(x; \zeta) \leq (\zeta p_c)^n \rho(o)^{n+1} \sum_x D^{(n)}(x) = (\zeta p_c)^n \rho(o)^{n+1}$, where $D^{(n)}$ denotes the n -fold convolution of D . Then for $n \geq 1$, $|f_n(k, z)| \leq \rho(o)^{-1} \sum_x t_n(x; \zeta) \leq (\zeta p_c \rho(o))^n = z^n$ so that f_n is bounded uniformly in $k \in [-\pi, \pi]^d$ and z in an n -dependent neighbourhood of 1. Continuity of the second derivatives holds for each n as the quantities in question are Fourier transforms of functions with finite support. An immediate consequence of Assumption S is that the mixed partials of f_n and g_n at $k = 0$ are all equal to zero.

Assumption D: By Definition 1.4 and Remark 1.5, (3.18) and (3.19) hold trivially. The remaining conditions (iii) are verified in [17].

We therefore turn our attention to verifying assumptions E and G. Recall from Definition 3.4 and (3.17) that for $n \geq 2$, g_n and e_n could be expressed in terms of the quantities $\widehat{\pi}_m$ for $m \leq n$. In Section 5 we will prove the following proposition.

Proposition 3.6 (π_m bounds). *For every $K \geq 1$ there exists $L_\pi(K) \geq 1$ such that: if (3.24) holds for all $L \geq L_0$, and $m \leq n$ with this K , for some $L_0 \geq L_\pi$ and $z \in (0, 2)$, then for this K, z and each $L \geq L_0$, $m \leq n + 1$ and $q \in \{0, 1, 2\}$,*

$$\sum_x |x|^{2q} |\pi_m(x; \zeta)| \leq \frac{C(K) \sigma^{2q} \beta^{2 - \frac{6\nu}{d}}}{m^{\frac{d-4}{2} - q}}, \quad (3.26)$$

where $\zeta = \rho(o)^{-1} p_c^{-1} z$, the constant $C = C(K, d)$ does not depend on L, m and z , and $\nu > 0$ is the constant appearing in Theorem 1.9.

We choose $\nu < 1$ in (1.4) so that $2 - \frac{6\nu}{d} > 1$ and therefore $\beta^{2 - \frac{6\nu}{d}} \leq \beta = L^{-\frac{d}{2}}$. We now direct our efforts towards verifying assumptions E and G, *in the case where the conditions in Proposition 3.6 are met.*

Assumption E: Suppose that there exist $K \geq 1$, $L_0 \geq L_\pi(K)$ and $z \in (0, 2)$ such that (3.24) holds for this K, z and all $L \geq L_0$ and $1 \leq m \leq n$. Fix such an L . Since $L_0 \geq L_\pi(K)$, Proposition 3.6 holds for $L \geq L_0$. Recall that $e_1(k; z) = 0$ and observe from (3.17) that

$$|e_2(k; z)| = \left| z \widehat{D}(k) \frac{\widehat{\pi}_1(k; \zeta)}{\rho(o)} + \frac{\widehat{\pi}_2(k; \zeta)}{\rho(o)} \right| \leq z \left| \frac{\widehat{\pi}_1(k; \zeta)}{\rho(o)} \right| + \left| \frac{\widehat{\pi}_2(k; \zeta)}{\rho(o)} \right| \leq \frac{C'(K) \beta^{2 - \frac{6\nu}{d}}}{2^{\frac{d-4}{2}}}, \quad (3.27)$$

where we have applied Proposition 3.6 with $|\widehat{\pi}_m(k; \zeta)| \leq \sum_x |\pi_m(x; \zeta)|$, and have also used $\rho(o) \geq 1$. Similarly for $3 \leq m \leq n + 1$,

$$\begin{aligned} |e_m(k; z)| &= \left| \widehat{\pi}_{m-2}(k; \zeta) z \widehat{D}(k) \frac{\widehat{\pi}_1(k; \zeta)}{\rho(o)^2} \right| + \left| \frac{\widehat{\pi}_m(k; \zeta)}{\rho(o)} \right| \\ &\leq \frac{C(K) \beta^{2 - \frac{6\nu}{d}}}{\rho(o)^2 (m-2)^{\frac{d-4}{2}}} z C(K) \beta^{2 - \frac{6\nu}{d}} + \frac{C(K) \beta^{2 - \frac{6\nu}{d}}}{\rho(o) m^{\frac{d-4}{2}}} \leq \frac{C'(K) \beta^{2 - \frac{6\nu}{d}}}{m^{\frac{d-4}{2}}}. \end{aligned} \quad (3.28)$$

Thus we have obtained the first bound of Assumption E. It follows immediately that for all $m \geq 1$,

$$|e_m(k; z) - e_m(0; z)| \leq |e_m(k; z)| + |e_m(0; z)| \leq \frac{C'(K)\beta^{2-\frac{6\nu}{d}}}{m^{\frac{d-4}{2}}},$$

for all $m \geq 2$. By (3.21) this satisfies the second bound of Assumption E for $\|k\|_\infty \geq L^{-1}$. Thus it remains to establish the second bound of Assumption E for $\|k\|_\infty \leq L^{-1}$, for which we use the method of [19].

Let $h : \mathbb{Z}^d \rightarrow \mathbb{R}$ be finitely supported and symmetric in each coordinate and under permutations of coordinates. Then $\widehat{h}(k) = \sum_x \cos(k \cdot x)h(x)$ and

$$\begin{aligned} \left| \widehat{h}(k) - \widehat{h}(0) \right| &\leq \left| \widehat{h}(k) - \widehat{h}(0) - \frac{|k|^2}{2d} \nabla^2 \widehat{h}(0) \right| + \frac{|k|^2}{2d} \left| \nabla^2 \widehat{h}(0) \right| \\ &= \left| \sum_x \left(\cos(k \cdot x) - 1 + \frac{1}{2}(k \cdot x)^2 \right) h(x) \right| + \frac{|k|^2}{2d} \left| \nabla^2 \widehat{h}(0) \right|. \end{aligned} \quad (3.29)$$

There exists a $c > 0$ such that for all $\eta \in [0, 1]$, $|\cos(t) - 1 + \frac{1}{2}t^2| \leq ct^{2+2\eta}$. Thus

$$\left| \widehat{h}(k) - \widehat{h}(0) \right| \leq C \sum_x |(k \cdot x)^{2+2\eta} h(x)| + \frac{|k|^2}{2d} \left| \nabla^2 \widehat{h}(0) \right|. \quad (3.30)$$

In particular choosing $\eta = 0$ we get

$$\left| \widehat{h}(k) - \widehat{h}(0) \right| \leq C|k|^2 \sum_x |x|^2 |h(x)|. \quad (3.31)$$

Now $e_m(k; z) - e_m(0; z)$ is equal to

$$(g_{m-1}(k; z) - g_{m-1}(0; z)) \frac{\widehat{\pi}_1(k; \zeta)}{\rho(o)} + g_{m-1}(0; z) \frac{\widehat{\pi}_1(k; \zeta) - \widehat{\pi}_1(0; \zeta)}{\rho(o)} + \frac{\widehat{\pi}_m(k; \zeta) - \widehat{\pi}_m(0; \zeta)}{\rho(o)}.$$

By (3.31) and Proposition 3.6 with $q = 1$ we have $|\widehat{\pi}_m(k; \zeta) - \widehat{\pi}_m(0; \zeta)| \leq C(K)|k|^2 \sigma^2 \beta^{2-\frac{6\nu}{d}} m^{-\frac{d-6}{2}}$. Therefore $|e_m(k; z) - e_m(0; z)|$ is bounded above by

$$\begin{aligned} &|g_{m-1}(k; z) - g_{m-1}(0; z)| \frac{|\widehat{\pi}_1(k; \zeta)|}{\rho(o)} + |g_{m-1}(0; z)| C(K) |k|^2 \frac{\sigma^2 \beta^{2-\frac{6\nu}{d}}}{\rho(o)} + C(K) |k|^2 \frac{\sigma^2 \beta^{2-\frac{6\nu}{d}}}{\rho(o) m^{\frac{d-6}{2}}} \\ &\leq \frac{C(K) \beta^{2-\frac{6\nu}{d}}}{\rho(o)} \left(|g_{m-1}(k; z) - g_{m-1}(0; z)| + |g_{m-1}(0; z)| |k|^2 \sigma^2 + \frac{|k|^2 \sigma^2}{m^{\frac{d-6}{2}}} \right). \end{aligned} \quad (3.32)$$

Recalling that $g_1(k; z) = z\widehat{D}(k)$ we have

$$|e_2(k; z) - e_2(0; z)| \leq \frac{C(K) \beta^{2-\frac{6\nu}{d}}}{\rho(o)} \left(za(k) + z|k|^2 \sigma^2 + \frac{|k|^2 \sigma^2}{2^{\frac{d-6}{2}}} \right). \quad (3.33)$$

For $m \geq 3$, recall that $g_{m-1}(k; z) = \frac{\widehat{\pi}_{m-2}(k; \zeta)}{\rho(o)} z \widehat{D}(k)$ which gives

$$\begin{aligned} |g_{m-1}(k; z) - g_{m-1}(0; z)| &\leq \frac{z}{\rho(o)} \left[|\widehat{\pi}_{m-2}(k; \zeta) - \widehat{\pi}_{m-2}(0; \zeta)| \widehat{D}(0) + a(k) |\widehat{\pi}_{m-2}(0; \zeta)| \right] \\ &\leq \frac{C(K) |k|^2 \sigma^2 \beta^{2-\frac{6\nu}{d}}}{(m-2)^{\frac{d-6}{2}}} + \frac{C(K) a(k) \beta^{2-\frac{6\nu}{d}}}{(m-2)^{\frac{d-4}{2}}}. \end{aligned} \quad (3.34)$$

Therefore for $m \geq 3$,

$$|e_m(k; z) - e_m(0; z)| \leq C(K) \beta^{2-\frac{6\nu}{d}} \left(\frac{|k|^2 \sigma^2 \beta^{2-\frac{6\nu}{d}}}{(m-2)^{\frac{d-6}{2}}} + \frac{a(k) \beta^{2-\frac{6\nu}{d}}}{(m-2)^{\frac{d-4}{2}}} + \frac{z |k|^2 \sigma^2 \beta^{2-\frac{6\nu}{d}}}{(m-2)^{\frac{d-4}{2}}} + \frac{|k|^2 \sigma^2}{m^{\frac{d-6}{2}}} \right). \quad (3.35)$$

Both (3.33) for $m = 2$ and (3.35) for $m \geq 3$ are bounded above by $C'(K) a(k) \beta m^{-\frac{d-6}{2}}$ for $\|k\|_\infty \leq L^{-1}$ by (3.20) and the fact that $\sigma^2 \sim L^2$ (see Remark 1.5).

Assumption G: Suppose that there exist $K \geq 1$, $L_0 \geq L_\pi(K)$ and $z \in (0, 2)$ such that (3.24) holds for this K, z and all $L \geq L_0$ and $1 \leq m \leq n$. As for Assumption E, we may apply Proposition 3.6 to obtain for this K, z and all $L \geq L_0$, $2 \leq m \leq n+1$,

$$|g_m(k; z)| = \left| z \widehat{D}(k) \frac{\widehat{\pi}_{m-1}(k; \zeta)}{\rho(o)} \right| \leq \frac{z C(K) \beta^{2-\frac{6\nu}{d}}}{\rho(o) (m-1)^{\frac{d-4}{2}}} \leq \frac{C'(K) \beta^{2-\frac{6\nu}{d}}}{m^{\frac{d-4}{2}}}, \quad (3.36)$$

which gives the first bound of Assumption G.

For the second bound we note that by symmetry the first derivatives of $\widehat{\pi}_m$ and \widehat{D} vanish at 0. Hence for $m \geq 2$,

$$\begin{aligned} |\nabla^2 g_m(0; z)| &= \left| \nabla^2 \left[z \widehat{D}(k) \frac{\widehat{\pi}_{m-1}(k; \zeta)}{\rho(o)} \right]_{k=0} \right| = \frac{z}{\rho(o)} |\nabla^2 \widehat{\pi}_{m-1}(0) + \widehat{\pi}_{m-1}(0) \nabla^2 \widehat{D}(0)| \\ &\leq \frac{z}{\rho(o)} \left(\frac{C(K) \beta^{2-\frac{6\nu}{d}} \sigma^2}{m^{\frac{d-6}{2}}} + \frac{C(K) \beta^{2-\frac{6\nu}{d}}}{m^{\frac{d-4}{2}}} \sigma^2 \right) \leq \frac{C'(K) \beta^{2-\frac{6\nu}{d}} \sigma^2}{m^{\frac{d-6}{2}}}. \end{aligned} \quad (3.37)$$

This verifies the second bound of Assumption G.

Next for $m \geq 2$, we have that

$$g_m(k; z) = \widehat{\pi}_{m-1}(k; \zeta) \frac{z \widehat{D}(k)}{\rho(o)} = z^m \left(\frac{\widehat{\pi}_{m-1}(k; \zeta)}{z^{m-1}} \right) \frac{\widehat{D}(k)}{\rho(o)}$$

where $\frac{\widehat{\pi}_{m-1}(k; \zeta)}{z^{m-1}}$ does not depend on z (or ζ). Therefore

$$|\partial_z g_m(k; z)| = \left| m z^{m-1} \left(\frac{\widehat{\pi}_{m-1}(k; \zeta)}{z^{m-1}} \right) \frac{\widehat{D}(k)}{\rho(o)} \right| = \left| m \widehat{\pi}_{m-1}(k; \zeta) \frac{\widehat{D}(k)}{\rho(o)} \right| \leq \frac{C'(K) \beta^{2-\frac{6\nu}{d}}}{m^{\frac{d-6}{2}}}, \quad (3.38)$$

which proves the third part of assumption G.

For $\|k\|_\infty \geq L^{-1}$, (3.21) applies and we have that for $m \geq 2$,

$$\begin{aligned} |g_m(k; z) - g_m(0; z) - a(k) \sigma^{-2} \nabla^2 g_m(0; z)| &\leq \frac{C'(K) \beta^{2-\frac{6\nu}{d}}}{m^{\frac{d-4}{2}}} + \frac{C'(K) \beta^{2-\frac{3\nu}{d}}}{m^{\frac{d}{4}}} + a(k) \frac{C'(K) \beta^{2-\frac{6\nu}{d}}}{m^{\frac{d-6}{2}}} \\ &\leq a(k)^2 \frac{C'_\eta(K) \beta^{2-\frac{6\nu}{d}}}{m^{\frac{d-6}{2}}}, \end{aligned} \quad (3.39)$$

since $a(k) > \eta$, and where the constant depends on η . This satisfies the final part of assumption G for $\|k\|_\infty \geq L^{-1}$.

For $\|k\|_\infty \leq L^{-1}$, we again use the method of [19]. By the triangle inequality we bound $|g_m(k; z) - g_m(0; z) - a(k)\sigma^{-2}\nabla^2 g_m(0; z)|$ by

$$\left|g_m(k; z) - g_m(0; z) - \frac{|k|^2}{2d}\nabla^2 g_m(0; z)\right| + \left|(a(k) - a(0))\sigma^{-2} - \frac{|k|^2}{2d}\right| |\nabla^2 g_m(0; z)|. \quad (3.40)$$

Recall that for $m \geq 2$, $g_m(k; z) = \frac{z}{\rho(o)}(\widehat{\pi_m * D})(k)$. On the first term we apply the analysis of the first term of (3.29), to the symmetric function $\pi_{m-1} * D$. Choosing $\eta = \epsilon'$ we see that the first term of (3.40) is bounded by

$$zC|k|^{2+2\epsilon'} \sum_x |x|^{2+2\epsilon'} |(\pi_{m-1} * D)(x)|, \quad (3.41)$$

with the constant independent of ϵ' . By Hölder's inequality

$$\sum_x |x|^{2+2\epsilon'} |(\pi_{m-1} * D)(x)| \leq \left(\sum_x |(\pi_{m-1} * D)(x)|\right)^{\frac{1-\epsilon'}{2}} \left(\sum_x |x|^4 |(\pi_{m-1} * D)(x)|\right)^{\frac{1+\epsilon'}{2}}. \quad (3.42)$$

Applying Proposition 3.6 with $q = 0$ gives

$$\sum_x |(\pi_{m-1} * D)(x)| \leq \sum_y |\pi_{m-1}(y)| \sum_x D(x-y) \leq \frac{C(K)\beta^{2-\frac{6\nu}{d}}}{m^{\frac{d-4}{2}}}. \quad (3.43)$$

We now apply Proposition 3.6 with $q = 0, 2$ together with the inequality $(a+b)^4 \leq 8(a^4 + b^4)$ to get

$$\begin{aligned} \sum_x |x|^4 |(\pi_{m-1} * D)(x)| &\leq 8 \left(\sum_y |y|^4 |\pi_{m-1}(y)| \sum_x D(x-y) + \sum_y |\pi_{m-1}(y)| \sum_x |x-y|^4 D(x-y) \right) \\ &\leq C \left(\sum_y |y|^4 |\pi_{m-1}(y)| + \sum_y |\pi_{m-1}(y)| \sigma^4 \right) \\ &\leq \frac{\sigma^4 C'(K)\beta^{2-\frac{6\nu}{d}}}{m^{\frac{d-8}{2}}}. \end{aligned} \quad (3.44)$$

Note that we have used Remark 1.5 to obtain $\sum_x |x|^r D(x) \leq C\sigma^r$ with the constant independent of L (it may depend on r). Putting (3.43) and (3.44) back into (3.42) we get

$$\sum_x |x|^{2+2\epsilon'} |(\pi_{m-1} * D)(x)| \leq \left(\frac{C(K)\beta^{2-\frac{6\nu}{d}}}{m^{\frac{d-4}{2}}}\right)^{\frac{1-\epsilon'}{2}} \left(\frac{\sigma^4 C'(K)\beta^{2-\frac{6\nu}{d}}}{m^{\frac{d-8}{2}}}\right)^{\frac{1+\epsilon'}{2}} \leq \frac{\sigma^{2(1+\epsilon')} C(K)\beta^{2-\frac{6\nu}{d}}}{m^{\frac{d-6}{2}-\epsilon'}}. \quad (3.45)$$

Combining (3.45) with (3.41) gives

$$\left| g_m(k; z) - g_m(0; z) - \frac{|k|^2}{2d} \nabla^2 g_m(0; z) \right| \leq \frac{C(K) \beta^{2-\frac{6\nu}{d}} (\sigma^2 |k|^2)^{1+\epsilon'}}{m^{\frac{d-6}{2}-\epsilon'}} \leq \frac{C(K) \beta^{2-\frac{6\nu}{d}} a(k)^{1+\epsilon'}}{m^{\frac{d-6}{2}-\epsilon'}}, \quad (3.46)$$

when $\|k\| \leq L^{-1}$. This satisfies the required final bound of Assumption G.

It remains to verify this bound for the term inside the second absolute value in expression (3.40). For this term we write

$$\left| \frac{a(k)}{\sigma^2} - \frac{|k|^2}{2d} \right| = \frac{1}{\sigma^2} \left| \widehat{D}(k) - \widehat{D}(0) - \frac{|k|^2}{2d} \nabla^2 \widehat{D}(0) \right|, \quad (3.47)$$

and proceed as for the first term to obtain

$$\left| \frac{1 - \widehat{D}(k)}{\sigma^2} - \frac{|k|^2}{2d} \right| \leq \frac{c|k|^{2+2\epsilon'}}{\sigma^2} \sum_x |x|^{2+2\epsilon'} |D(x)| \leq \frac{c|k|^{2+2\epsilon'}}{\sigma^2} L^{2(1+\epsilon')}.$$

Together with Proposition 3.6 with $q = 1$ this gives

$$\left| (1 - \widehat{D}(k)) \sigma^{-2} - \frac{|k|^2}{2d} \right| |\nabla^2 g_m(0; z)| \leq \frac{C(K) \beta^{2-\frac{6\nu}{d}} \sigma^2 (|k|^2 L^2)^{1+\epsilon'}}{m^{\frac{d-6}{2}} \sigma^2},$$

which satisfies the required final bound of Assumption G for $\|k\| \leq L^{-1}$.

We have now verified that Assumptions S,D,E,G all hold, provided $L \geq L_\pi$, i.e. assuming that Proposition 3.6 holds. Thus assuming Proposition 3.6, we may apply the induction method of [15] and obtain the following theorem.

Theorem 3.7. *Fix $d > 8$, $\gamma \in (0, 1 \wedge \frac{d-8}{2})$ and $\delta \in (0, (1 \wedge \frac{d-8}{2}) - \gamma)$. There exists a positive $L_0 = L_0(d)$ such that: For every $L \geq L_0$ there exist A', v, z_c depending on d and L such that the following statements hold:*

(a)

$$\rho(o)^{-1} \widehat{t}_n \left(\frac{k}{\sqrt{v\sigma^2 n}}; \frac{z_c}{\rho(o)p_c} \right) = A' e^{-\frac{|k|^2}{2d}} \left[1 + \mathcal{O} \left(\frac{|k|^2}{n^\delta} \right) + \mathcal{O} \left(\frac{1}{n^{\frac{d-8}{2}}} \right) \right], \quad (3.48)$$

with the error estimate uniform in $\{k \in \mathbb{R}^d : 1 - \widehat{D}(k/\sqrt{v\sigma^2 n}) \leq \gamma n^{-1} \log n\}$.

(b)

$$-\frac{\nabla^2 \widehat{t}_n \left(0; \frac{z_c}{\rho(o)p_c} \right)}{\widehat{t}_n \left(0; \frac{z_c}{\rho(o)p_c} \right)} = v\sigma^2 n \left[1 + \mathcal{O} \left(\frac{1}{L^{\frac{d}{2}} n^\delta} \right) \right].$$

(c) For every $p \geq 1$,

$$\left\| \widehat{D}^2 \widehat{t}_n \left(\cdot; \frac{z_c}{\rho(o)p_c} \right) \right\|_p \leq \frac{C}{L^{\frac{d}{p}} n^{\frac{d}{2p} \wedge \frac{d-8}{2}}}.$$

(d) The constants z_c , A' and v are all $1 + \mathcal{O}\left(L^{-\frac{d}{2}}\right)$ and

$$1 = \sum_{m=1}^{\infty} g_m(0; z_c), \quad A' = \frac{1 + \sum_{m=1}^{\infty} e_m(0; z_c)}{\sum_{m=1}^{\infty} m g_m(0; z_c)}, \quad v = -\frac{\sum_{m=1}^{\infty} \nabla^2 g_m(0; z_c)}{\sigma^2 \sum_{m=1}^{\infty} m g_m(0; z_c)}. \quad (3.49)$$

In particular, provided Proposition 3.6 holds, the induction method shows that there exists $L_0, K \geq 1$ such that (3.24) holds for all m and all $L \geq L_0$ for this K . The induction method itself is rather complicated but is logically structured as follows: Firstly we find the functions C_e and C_g in Assumptions E and G, as appears in the verification of these assumptions for large L above. The induction method then defines a host of constants including K , that are independent of L , but depend on the functions C_e, C_g . It also identifies $L_{ind} \gg 1$, depending on these constants, for which it is required that $L \geq L_{ind}$ to advance (3.24). One then chooses $L_0 = L_\pi \vee L_{ind}$, so that Proposition 3.6 holds and the advancement of (3.24) for all $L \geq L_0$ for our chosen K .

3.4 Proof of Theorem 1.12

In this section we show that Theorem 1.12 follows from Theorem 3.7(a). Comparing the two theorems and setting $A = A' \rho(o)$ (recall that $\zeta_c = z_c \rho(o)^{-1} p_c^{-1}$), it is clear that to prove Theorem 1.12 it is sufficient to prove the following two lemmas. The first incorporates the continuous time variable t into the asymptotic formula (3.48), while the second confirms that our artificially introduced parameter ζ is trivial.

Lemma 3.8. For d, γ, δ and L_0 as in Theorem 3.7, there exists a constant $C_0 = C_0(d, \gamma) > 0$ such that

$$\hat{t}_{\lfloor nt \rfloor} \left(\frac{k}{\sqrt{v\sigma^2 n}}; \zeta_c \right) = A e^{-\frac{|k|^2}{2d} t} + \mathcal{O} \left(\frac{|k|^2}{n} \right) + \mathcal{O} \left(\frac{|k|^2 t^{1-\delta}}{n^\delta} \right) + \mathcal{O} \left(\frac{1}{(nt \vee 1)^{\frac{d-8}{2}}} \right),$$

with the error estimates uniform in $\{k \in \mathbb{R}^d : |k|^2 \leq C_0 t^{-1} \log(\lfloor nt \rfloor \vee 1)\}$.

Lemma 3.9. The critical value $\zeta_c \equiv \frac{z_c}{\rho(o) p_c} = 1$.

Proof of Lemma 3.8. The statement is trivial for $\lfloor nt \rfloor = 0$, so we assume that $\lfloor nt \rfloor \geq 1$. Incorporating a time variable into (3.48) by $n \mapsto \lfloor nt \rfloor$, $k \mapsto k \sqrt{\frac{\lfloor nt \rfloor}{n}}$ we have that $\hat{t}_{\lfloor nt \rfloor} \left(\frac{k}{\sqrt{v\sigma^2 n}}; \zeta_c \right)$ is equal to

$$\hat{t}_{\lfloor nt \rfloor} \left(\frac{k \sqrt{\frac{\lfloor nt \rfloor}{n}}}{\sqrt{v\sigma^2 \lfloor nt \rfloor}}; \zeta_c \right) = A e^{-\frac{|k|^2 \lfloor nt \rfloor}{2dn}} \left[1 + \mathcal{O} \left(\frac{|k|^2 \lfloor nt \rfloor^{1-\delta}}{n} \right) + \mathcal{O} \left(\frac{1}{\lfloor nt \rfloor^{\frac{d-8}{2}}} \right) \right], \quad (3.50)$$

where the error estimate is uniform in

$$\mathbf{H}_{n,t} \equiv \left\{ k \in \mathbb{R}^d : 1 - D \left(\frac{k \sqrt{\frac{\lfloor nt \rfloor}{n}}}{\sqrt{v\sigma^2 \lfloor nt \rfloor}} \right) \leq \gamma \lfloor nt \rfloor^{-1} \log \lfloor nt \rfloor \right\}.$$

We leave it as an exercise to show that there exists a constant C_0 such that $\{k : |k|^2 \leq C_0 t^{-1} \log(\lfloor nt \rfloor)\} \subset \mathbf{H}_{n,t}$, and thus (3.50) holds with the error estimate uniform in $\{k : |k|^2 \leq C_0 \log(\lfloor nt \rfloor)\}$. Since $\lfloor nt \rfloor \leq nt$ in the first error term of (3.50), and

$$\left| e^{-\frac{|k|^2 \lfloor nt \rfloor}{2dn}} - e^{-\frac{|k|^2 t}{2d}} \right| \leq \frac{|k|^2}{2d} \left(t - \frac{\lfloor nt \rfloor}{n} \right) = \mathcal{O} \left(\frac{|k|^2}{n} \right),$$

we have proved Lemma 3.8. □

Proof of Lemma 3.9. The susceptibility, $\chi(z)$ is

$$\chi(z) \equiv \sum_n f_n(0; z) = \sum_n \frac{\widehat{t}_n(0; \zeta)}{\rho(o)} = \sum_n \zeta^n \frac{1}{\rho(o)} \sum_x \sum_{T \in \mathcal{T}_n(x)} W(T) \equiv \bar{\chi}(\zeta), \quad (3.51)$$

where $\zeta = z\rho(o)^{-1}p_c^{-1}$. By Theorem 3.7 there exists a ζ_c such that

$$\zeta_c^n \frac{1}{\rho(o)} \sum_x \sum_{T \in \mathcal{T}_n(x)} W(T) \rightarrow A > 0, \quad (3.52)$$

so that

$$\left(\frac{1}{\rho(o)} \sum_x \sum_{T \in \mathcal{T}_n(x)} W(T) \right)^{\frac{1}{n}} \rightarrow \frac{1}{\zeta_c}.$$

Thus the radius of convergence of $\bar{\chi}(\zeta)$ is $\zeta_c > 0$. Since $\sum_{|x| < M} (|x| \vee 1)^{a-d} \simeq M^a$, it follows from Theorem 1.9 that $\bar{\chi}(1) = \infty$ which implies that $\zeta_c \leq 1$.

For $\zeta < 1$, $\sum_n \zeta^n t_n(x) \leq e^{-c(\zeta)|x|} \rho(x)$, which implies that

$$\sum_x \zeta^n t_n(x) \leq (\sqrt{\zeta})^n \sum_x \sum_{m \geq n} (\sqrt{\zeta})^m t_m(x) \leq (\sqrt{\zeta})^n \sum_x e^{-c'(\zeta)|x|} \rho(x), \quad (3.53)$$

which goes to 0 as $n \rightarrow \infty$. Hence $\zeta_c \geq 1$ and the result follows. □

Assuming that Proposition 3.6 holds, we have now verified Lemmas 3.8 and 3.9, and hence we have proved Theorem 1.12. We postpone the proof of Proposition 3.6 to Section 5.

4 The r -point functions

We have shown Gaussian behaviour (Theorem 1.12) of the 2-point function with appropriate scaling in Section 3. We now wish to prove the analogous result for r -point functions, Theorem 1.14. The proof is by induction on r , having already verified the initializing case $r = 2$ in Section 3. We use the technology of the lace expansion on a tree [19] as expressed in Section 2, and prove the result assuming certain diagrammatic bounds. The diagrammatic estimates are postponed until Section 6.

4.1 Preliminaries

Recall from Definitions 1.3 and 1.13 that for fixed $r \geq 2$, $\tilde{\mathbf{n}} \in \mathbb{Z}_+^{r-1}$ and $\tilde{\mathbf{x}} \in \mathbb{R}^{d(r-1)}$, we have

$$\mathcal{T}_{\tilde{\mathbf{n}}}(\tilde{\mathbf{x}}) = \{T \in \mathcal{T}(o) : \mathbf{x}_i \in T_{\mathbf{n}_i}, i = 1, \dots, r-1\}$$

and

$$t_{\tilde{\mathbf{n}}}^r(\tilde{\mathbf{x}}) = \sum_{T \in \mathcal{T}_{\tilde{\mathbf{n}}}(\tilde{\mathbf{x}})} W(T),$$

where we may have $\mathbf{x}_i = \mathbf{x}_j$ and $\mathbf{n}_i = \mathbf{n}_j$ for some $i \neq j$. For $T \in \mathcal{T}(o, x)$, let $T_{\rightsquigarrow x}$ be the backbone in T from 0 to x .

Definition 4.1 (Bare tree). For $\tilde{\mathbf{n}} \in \mathbb{Z}_+^{r-1}$ and $\tilde{\mathbf{x}} \in \mathbb{Z}_+^{d(r-1)}$, a lattice tree B is said to be an $(\tilde{\mathbf{n}}, \tilde{\mathbf{x}})$ bare tree if $B \in \mathcal{T}_{\tilde{\mathbf{n}}}(\tilde{\mathbf{x}})$ and $\cup_{i=1}^{r-1} B_{\rightsquigarrow \mathbf{x}_i} = B$. We let $\mathbf{B}(\tilde{\mathbf{n}}, \tilde{\mathbf{x}})$ denote the set of $(\tilde{\mathbf{n}}, \tilde{\mathbf{x}})$ bare trees. If $B \in \mathbf{B}(\tilde{\mathbf{n}}, \tilde{\mathbf{x}})$ then we write $\mathcal{T}_B = \{T \in \mathcal{T}(o) : B \subseteq T\}$ for the set of lattice trees containing B as a subtree.

Since every $T \in \mathcal{T}_{\tilde{\mathbf{n}}}(\tilde{\mathbf{x}})$ has a unique minimal connected subtree $(\cup_{i=1}^{r-1} T_{\rightsquigarrow \mathbf{x}_i})$ connecting 0 to the \mathbf{x}_i , $i = 1, \dots, r-1$, we have

$$t_{\tilde{\mathbf{n}}}^r(\tilde{\mathbf{x}}) = \sum_{B \in \mathbf{B}(\tilde{\mathbf{n}}, \tilde{\mathbf{x}})} \sum_{T \in \mathcal{T}_B} W(T). \quad (4.1)$$

The degree of a vertex $x \in B$ is the number of bonds $\{a, b\} \in B$ such that either $a = x$ or $b = x$.

Definition 4.2 (Branch point). Let $B \in \mathbf{B}(\tilde{\mathbf{n}}, \tilde{\mathbf{x}})$. A vertex $x \in B$ is a branch point of B if there exist $i \neq j$ such that $\mathbf{x}_i \neq o$ and $\mathbf{x}_j \neq o$ are distinct leaves (vertices of degree 1) of B and $B_{\rightsquigarrow \mathbf{x}_i} \cap B_{\rightsquigarrow \mathbf{x}_j} = B_{\rightsquigarrow x}$.

As they are defined in terms of the leaves of $B \in \mathbf{B}(\tilde{\mathbf{n}}, \tilde{\mathbf{x}})$, branch points of B depend on B but not the set $\mathbf{B}(\tilde{\mathbf{n}}, \tilde{\mathbf{x}})$ of which B is a member. In particular if B is also in $\mathbf{B}(\tilde{\mathbf{n}}', \tilde{\mathbf{x}}')$ then our definition gives rise to the same set of branch points. By definition, a branch point that is not the origin must have degree ≥ 3 . It is clear that the number of leaves $\neq o$ is at least 1 plus the number of branch points, so if $B \in \mathbf{B}(\tilde{\mathbf{n}}, \tilde{\mathbf{x}})$ for $\tilde{\mathbf{x}} \in \mathbb{Z}^{d(r-1)}$ then B contains at most $r-2$ branch points.

Definition 4.3 (Degenerate bare tree). For fixed $r \geq 3$, $\tilde{\mathbf{n}} \in \mathbb{Z}_+^{r-1}$ and $\tilde{\mathbf{x}} \in \mathbb{R}^{d(r-1)}$, a bare tree $B \in \mathbf{B}(\tilde{\mathbf{n}}, \tilde{\mathbf{x}})$ is said to be non-degenerate if B contains exactly $r-2$ distinct branch points, each of degree 3, none of which is the origin. Otherwise B is said to be degenerate. We write $\mathbf{B}_D(\tilde{\mathbf{n}}, \tilde{\mathbf{x}})$ for the set of degenerate trees in $\mathbf{B}(\tilde{\mathbf{n}}, \tilde{\mathbf{x}})$ and set $\mathbf{B}_D^c(\tilde{\mathbf{n}}, \tilde{\mathbf{x}}) = \mathbf{B}(\tilde{\mathbf{n}}, \tilde{\mathbf{x}}) \setminus \mathbf{B}_D(\tilde{\mathbf{n}}, \tilde{\mathbf{x}})$.

Clearly from (4.1) we have

$$t_{\tilde{\mathbf{n}}}^r(\tilde{\mathbf{x}}) = \sum_{B \in \mathbf{B}_D^c(\tilde{\mathbf{n}}, \tilde{\mathbf{x}})} \sum_{T \in \mathcal{T}_B} W(T) + \sum_{B \in \mathbf{B}_D(\tilde{\mathbf{n}}, \tilde{\mathbf{x}})} \sum_{T \in \mathcal{T}_B} W(T). \quad (4.2)$$

Definition 4.4. Let $B \in \mathbf{B}(\tilde{\mathbf{n}}, \tilde{\mathbf{x}})$. Two distinct vertices y, y^* in B are said to be net-neighbours in B if the unique path in B from y to y^* contains no branch points of B other than (perhaps) y, y^* . A net-path in B is a path in B connecting the origin or a branch point in B to a net-neighbouring branch point or leaf in B .

Lemma 4.5. Fix $r \geq 3$, $\tilde{\mathbf{n}} \in \mathbb{N}^{r-1}$, $\tilde{\mathbf{x}} \in \mathbb{Z}^{d(r-1)}$.

1. If $B \in \mathbf{B}_D^c(\tilde{\mathbf{n}}, \tilde{\mathbf{x}})$ then B consists of $2r - 3$ net-paths joined together with the topology of α for some $\alpha \in \Sigma_r$.
2. If $B \in \mathbf{B}_D(\tilde{\mathbf{n}}, \tilde{\mathbf{x}})$ then B contains fewer than $2r - 3$ nonempty netpaths and fewer than $r - 2$ branch points that are not the origin.

Proof. By induction on r . For $r = 3$, the nondegenerate bare trees satisfy the claim since they contain exactly one branch point, of degree 3. All degenerate bare trees have fewer netpaths as there can be at most one branch point and it can only be the origin. Suppose the result holds for all $r' < r$.

If $B \in \mathbf{B}_D^c(\tilde{\mathbf{n}}, \tilde{\mathbf{x}})$ then B contains $r - 2$ branch points, each of which is of degree 3, none of which is the origin. This implies that the \mathbf{x}_j are all distinct leaves, and not the origin (otherwise $B \in \mathbf{B}(\tilde{\mathbf{n}}', \tilde{\mathbf{x}}')$ for some $\tilde{\mathbf{n}}' \in \mathbb{Z}_+^{r-2}$ and $\tilde{\mathbf{x}}' \in \mathbb{Z}^{d(r-2)}$ but has $r - 2$ branch points). Let $x \neq o, \mathbf{x}_{r-1}$ be the unique branch point in B net-neighbouring \mathbf{x}_{r-1} . Removing the netpath $B_{\rightsquigarrow \mathbf{x}_{r-1}} \setminus B_{\rightsquigarrow x}$, we have that x is a vertex of degree 2 in $B^* = B \setminus (B_{\rightsquigarrow \mathbf{x}_{r-1}} \setminus B_{\rightsquigarrow x})$ and therefore B^* contains $r - 3$ branchpoints, each of degree 3, none of which is the origin. Thus $B^* \in \mathbf{B}((\mathbf{n}_1, \dots, \mathbf{n}_{r-2}), (\mathbf{x}_1, \dots, \mathbf{x}_{r-2}))$. By definition of a netpath and the fact that x is not a branch point of B^* , we see that B^* contains two fewer netpaths than B . By the induction hypothesis, B^* consists of $2(r - 1) - 3$ net paths joined together with the topology of α^* for some $\alpha^* \in \Sigma_{r-1}$. Therefore B contained $2r - 3$ netpaths joined together with the topology of $\alpha \in \Sigma_{r-1}$, where α is the shape obtained by adding a vertex to the edge of α^* corresponding to the unique net-path in B^* containing x and adding an edge to that vertex.

Suppose instead that $B \in \mathbf{B}_D(\tilde{\mathbf{n}}, \tilde{\mathbf{x}})$. If any $\mathbf{x}_j = o$ or $\mathbf{x}_i = \mathbf{x}_j$ then $B \in \mathbf{B}(\tilde{\mathbf{n}}', \tilde{\mathbf{x}}')$ for some $\tilde{\mathbf{n}}' \in \mathbb{Z}_+^{r-2}$ and $\tilde{\mathbf{x}}' \in \mathbb{Z}^{d(r-2)}$ and the result holds by the induction hypothesis. Otherwise we use the same decomposition as for part 1, and let the degree of the branch point $x \neq 0$ be l . If $l = 3$ then B^* above is a degenerate bare tree and the result hold by induction. If $l > 3$ then B^* contains one fewer netpath and the same number of branch points as B . By induction $B^* \in \mathbf{B}((\mathbf{n}_1, \dots, \mathbf{n}_{r-2}), (\mathbf{x}_1, \dots, \mathbf{x}_{r-2}))$ contains at most $2(r - 1) - 3$ netpaths and $(r - 1) - 2 = r - 3$ branch points that are not the origin. Therefore B contained at most $2r - 4$ netpaths and $r - 3$ branch points that are not the origin. \square

We have thus far been dealing with descriptions of trees specified only up to the location of fixed points $\tilde{\mathbf{x}}$ at distances $\tilde{\mathbf{n}}$ from the origin. We now introduce further notation of the form \vec{y}, \vec{n} that refers to displacements and lengths of the netpaths of a bare tree.

Definition 4.6. Let $\mathcal{M} = \mathcal{M}(\vec{n})$ be any network containing l labelled edges joined together with arbitrary topology with $n_j - 1 \in \mathbb{Z}_+$ vertices being added to edge j for each $j \in \{1, \dots, l\}$. Let $B \in \mathbf{B}(\tilde{\mathbf{n}}, \tilde{\mathbf{x}})$. We say that B has network shape \mathcal{M} if B and \mathcal{M} are graph isomorphic and for each i the graph isomorphism maps leaf i of \mathcal{M} to \mathbf{x}_i (where $\mathbf{x}_0 = 0$). For $\vec{y} = (y_1, \dots, y_{2r-3}) \in \mathbb{Z}^{dl}$, we define $\mathcal{T}_{\mathcal{M}}(\vec{y})$ to be the set of lattice trees $T \in \mathcal{T}(o)$ such that there exists $\tilde{\mathbf{x}}, \tilde{\mathbf{n}}$ and $B \in \mathbf{B}(\tilde{\mathbf{n}}, \tilde{\mathbf{x}})$ such that

1. $T \in \mathcal{T}_B$,
2. B has network shape \mathcal{M} , and

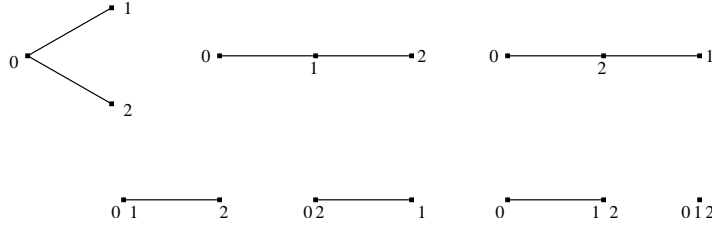

Figure 12: The seven possible degenerate shapes for $r = 3$. The second (resp. third) shape is only a possible candidate for the shape of $B \in \mathbf{B}_D(\tilde{\mathbf{n}}, \tilde{\mathbf{x}})$ if $\mathbf{n}_2 > \mathbf{n}_1$ (resp. $\mathbf{n}_2 < \mathbf{n}_1$).

3. if the endvertices of netpath B_j are $u_j, v_j \in \mathbb{R}^d$, where $B_{\rightsquigarrow u_j} \subset B_{\rightsquigarrow v_j}$ then $v_j - u_j = y_j$, for each $j = 1, \dots, 2r - 3$.

We then define

$$t_{\mathcal{M}}(\vec{y}) = \sum_{T \in \mathcal{T}_{\mathcal{M}}(\vec{y})} W(T). \quad (4.3)$$

By ignoring the interaction between the branches emanating from different net-paths in each B with network shape \mathcal{M} and using Lemma 5.10 with $l = 1$ and $q = 0$, it is easy to prove that

$$\sum_{\vec{y}} t_{\mathcal{M}}(\vec{y}) \leq K^l. \quad (4.4)$$

We wish to rewrite (4.2) in terms of a sum over underlying network shapes that describe the possible bare trees connecting the \mathbf{x}_i and 0. For a fixed shape $\alpha \in \Sigma_r$ (with fixed but arbitrary edge labelling) and $\vec{n} \in \mathbb{N}_+^{2r-3}$, we let $\mathcal{N}(\alpha, \vec{n})$ be the abstract *network shape* obtained by inserting $n_j - 1$ vertices onto edge j of α , $j = 1, \dots, 2r - 3$. Each edge j of α has two vertices j_1, j_2 in α incident to it. We define *branch* \mathcal{N}_j of \mathcal{N} to be the smallest connected subnetwork of \mathcal{N} that contains the vertices j_1, j_2 .

Suppose $T \in \mathcal{T}_{\mathcal{N}(\alpha, \vec{n})}(\vec{y})$, with corresponding $\tilde{\mathbf{x}}, \tilde{\mathbf{n}}, B$ as in Definition 4.6. Since B has shape $\mathcal{N}(\alpha, \vec{n})$, we may label the netpaths $\{B_1, \dots, B_{2r-3}\}$ of B according to the edge labels $\{1, \dots, 2r-3\}$ of α . Let $E_i = \{j : B_j \subset B_{\rightsquigarrow \mathbf{x}_i}\}$ denote the set of labels of edges in the unique path in α from the root to leaf i . By definition we have $\sum_{j \in E_i} y_j = \mathbf{x}_i$ and $\sum_{j \in E_i} n_j = \mathbf{n}_i$. See Figure 13 for an illustration of this.

Lemma 4.5 implies that if $T \in \mathcal{T}_B$ for some $B \in \mathbf{B}_D^c(\tilde{\mathbf{n}}, \tilde{\mathbf{x}})$, then $T \in \mathcal{T}_{\mathcal{N}(\alpha, \vec{n})}(\vec{y})$ for some $\alpha \in \Sigma_r$, $\vec{n} \in \mathbb{N}^{2r-3}$, $\vec{y} \in \mathbb{Z}^{d(2r-3)}$ satisfying $\sum_{j \in E_i} n_j = \mathbf{n}_i$, $\sum_{j \in E_i} y_j = \mathbf{x}_i$, $i \in \{1, \dots, r-1\}$. On the other hand suppose $T \in \mathcal{T}_{\mathcal{N}(\alpha, \vec{n})}(\vec{y})$. Let \mathbf{x}_i be the vertex in T corresponding to leaf i of α , $i = 1, \dots, r-1$, and let \mathbf{n}_i be the number of edges in $T_{\rightsquigarrow \mathbf{x}_i}$. Then $T \in \mathcal{T}_{\tilde{\mathbf{n}}}(\tilde{\mathbf{x}})$ by definition. Choosing $B = \cup_{i=1}^{r-1} T_{\rightsquigarrow \mathbf{x}_i}$, it is easy to see that $B \in \mathbf{B}(\tilde{\mathbf{n}}, \tilde{\mathbf{x}})$ and $T \in \mathcal{T}_B$. Finally since $\mathcal{N}(\alpha, \vec{n})$ contains $r-2$ distinct branch points, each of degree 3 (of which none are the origin), B must also have this property and thus $B \in \mathbf{B}_D^c(\tilde{\mathbf{n}}, \tilde{\mathbf{x}})$.

For fixed $\alpha \in \Sigma_r$, $\tilde{\mathbf{n}} \in \mathbb{N}^{r-1}$ and $\tilde{\mathbf{x}} \in \mathbb{Z}^{d(r-1)}$ we write $\sum_{\vec{n}, \vec{y} \rightsquigarrow \tilde{\mathbf{n}}}$ to denote the sum over $\{\vec{n} \in \mathbb{N}^{2r-3} : \sum_{j \in E_i} n_j = \mathbf{n}_i, i = 1, \dots, r-1\}$, and $\sum_{\vec{y} \rightsquigarrow \tilde{\mathbf{x}}}$ to denote the sum over $\{\vec{y} \in \mathbb{Z}^{d(2r-3)} : \sum_{j \in E_i} y_j = \mathbf{x}_i, i = 1, \dots, r-1\}$. Then

$$\sum_{B \in \mathbf{B}_D^c(\tilde{\mathbf{n}}, \tilde{\mathbf{x}})} \sum_{T \in \mathcal{T}_B} W(T) = \sum_{\alpha \in \Sigma_r} \sum_{\vec{n}, \vec{y} \rightsquigarrow \tilde{\mathbf{n}}} \sum_{\vec{y} \rightsquigarrow \tilde{\mathbf{x}}} \sum_{T \in \mathcal{T}_{\mathcal{N}(\alpha, \vec{n})}(\vec{y})} W(T). \quad (4.5)$$

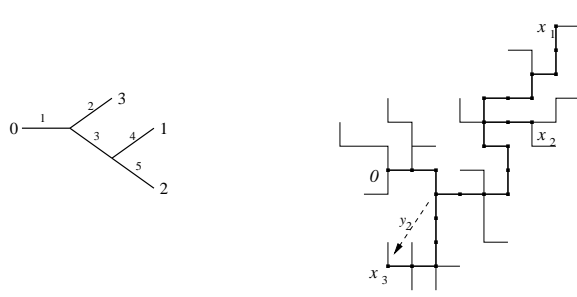

Figure 13: A shape $\alpha \in \Sigma_4$ with labelled edges, and a nearest neighbour lattice tree $T \in \mathcal{T}_{\mathcal{N}(\alpha, \vec{n})}(\vec{y})$ for $\vec{n} = (3, 5, 7, 7, 2)$, $\vec{y} = ((2, -1), (-2, -3), (2, 3), (3, 4), (2, 0))$. Also $T \in \mathcal{T}_{\vec{n}}(\vec{x})$ where $\vec{n} = (17, 12, 8)$ and $\vec{x} = ((7, 6), (6, 2), (0, -4))$. Note for example that $y_1 + y_3 + y_4 = x_1$.

Definition 4.7 (Degenerate Shape). For $r \geq 3$, let $\overline{\Sigma}_r$ be the set of rooted trees $\bar{\alpha}$ such that the root is labelled 0 and

1. $\bar{\alpha}$ contains fewer than $2r - 3$ edges, and fewer than $r - 2$ branch points (vertices of degree ≥ 3) that are not the root, and
2. for each $i \in \{0, \dots, r - 1\}$ there exists a vertex in $\bar{\alpha}$ with label i , and each leaf (vertex of degree 1) of $\bar{\alpha}$ has labels from the set $\{0, \dots, r - 1\}$.

We call $\bar{\alpha} \in \overline{\Sigma}_r$ a degenerate shape. Clearly there are only finitely many degenerate shapes for each fixed r . See Figure 12 for the set $\overline{\Sigma}_3$.

By Definition 4.3 and Lemma 4.5, if $B \in \mathbf{B}_D(\vec{n}, \vec{x})$ for some $\vec{n} \in \mathbb{Z}_+^{r-1}$ and $\vec{x} \in \mathbb{Z}^{d(r-1)}$ then B has the topology of some $\bar{\alpha} \in \overline{\Sigma}_r$. For $\bar{\alpha} \in \overline{\Sigma}_r$ consisting of $l < 2r - 3$ edges and $\vec{n} \in \mathbb{N}^l$ we define $\mathcal{D}(\bar{\alpha}, \vec{n})$ to be the abstract network shape obtained by inserting $n_j - 1$ vertices onto edge j of $\bar{\alpha}$, $j = 1, \dots, l$. Then

$$\begin{aligned} \sum_{\vec{x}} \sum_{B \in \mathbf{B}_D(\vec{n}, \vec{x})} \sum_{T \in \mathcal{T}_B} W(T) &\leq \sum_{\bar{\alpha} \in \overline{\Sigma}_r} \sum_{\vec{n} \in \mathbb{N}^{\bar{\alpha}}} \sum_{\vec{x}} \sum_{\vec{y} \in \bar{\alpha}, \vec{x}} \sum_{T \in \mathcal{T}_{\mathcal{D}(\bar{\alpha}, \vec{n})}(\vec{y})} W(T) \\ &= \sum_{\bar{\alpha} \in \overline{\Sigma}_r} \sum_{\vec{n} \in \mathbb{N}^{\bar{\alpha}}} \hat{t}_{\mathcal{D}(\bar{\alpha}, \vec{n})}(\vec{0}). \end{aligned} \quad (4.6)$$

Note that for any given $\vec{n} \in \mathbb{N}^{r-1}$ we may have many $\bar{\alpha} \in \overline{\Sigma}_r$ for which the set $\{\vec{n} : \vec{n} \overset{\bar{\alpha}}{\rightsquigarrow} \vec{n}\}$ is empty.

Recall the definition of $\vec{\kappa}$ from (1.8). The main result of this section is the following theorem.

Theorem 4.8. Fix $d > 8$, $\gamma \in (0, 1 \wedge \frac{d-8}{2})$ and $\delta \in (0, (1 \wedge \frac{d-8}{2}) - \gamma)$. There exists $L_0 = L_0(d, \gamma) \gg 1$ such that: For each $L \geq L_0$ there exists $V = V(d, L) > 0$ such that for every $r \geq 2$, $\alpha \in \Sigma_r$, $\vec{n} \in \mathbb{N}^{2r-3}$, $R > 0$, and $\vec{\kappa} \in [-R, R]^{(2r-3)d}$,

$$\hat{t}_{\mathcal{N}(\alpha, \vec{n})} \left(\frac{\vec{\kappa}}{\sqrt{\sigma^2 v n}} \right) = V^{r-2} A^{2r-3} \prod_{j=1}^{2r-3} e^{-\frac{\kappa_j^2}{2d} \left(\frac{n_j}{n} \right)} + \mathcal{O} \left(\sum_{j=1}^{2r-3} \frac{1}{n_j^{\frac{d-8}{2}}} \right) + \mathcal{O} \left(\sum_{j=1}^{2r-3} \frac{|\kappa_j|^{2n_j^{1-\delta}}}{n} \right), \quad (4.7)$$

where A and v are the constants appearing in Theorem 1.12 and the constants in the error terms may depend on r and R .

In view of (4.2) and (4.5) we have that

$$\begin{aligned} \widehat{t}_{\tilde{\mathbf{n}}}^r(\tilde{\mathbf{k}}) &= \sum_{\tilde{\mathbf{x}}} e^{i\tilde{\mathbf{k}} \cdot \tilde{\mathbf{x}}} \sum_{\alpha \in \Sigma_r} \sum_{\tilde{n} \rightsquigarrow \tilde{\mathbf{n}}} \sum_{\vec{y} \rightsquigarrow \tilde{\mathbf{x}}} t_{\mathcal{N}(\alpha, \tilde{n})}(\vec{y}) + \sum_{\tilde{\mathbf{x}}} e^{i\tilde{\mathbf{k}} \cdot \tilde{\mathbf{x}}} \sum_{B \in \mathbf{B}_D(\tilde{\mathbf{n}}, \tilde{\mathbf{x}})} \sum_{T \in \mathcal{T}_B} W(T) \\ &\equiv \sum_{\tilde{\mathbf{x}}} e^{i\tilde{\mathbf{k}} \cdot \tilde{\mathbf{x}}} \sum_{\alpha \in \Sigma_r} \sum_{\tilde{n} \rightsquigarrow \tilde{\mathbf{n}}} \sum_{\vec{y} \rightsquigarrow \tilde{\mathbf{x}}} t_{\mathcal{N}(\alpha, \tilde{n})}(\vec{y}) + \widehat{\phi}_{\tilde{\mathbf{n}}}^r(\tilde{\mathbf{k}}). \end{aligned} \quad (4.8)$$

The following Lemma 4.9 will be used to show that the contribution $\widehat{\phi}$ from degenerate trees gives rise to an error term.

Lemma 4.9. For all $\tilde{\mathbf{k}} \in [-\pi, \pi]^{(r-1)d}$,

$$|\widehat{\phi}_{\tilde{\mathbf{n}}}^r(\tilde{\mathbf{k}})| \leq C_r \|\tilde{\mathbf{n}}\|_{\infty}^{r-3}. \quad (4.9)$$

Proof. Let $l = l(\bar{\alpha})$ be the number of edges in $\bar{\alpha}$. Applying (4.4) to \mathcal{D} we obtain

$$\widehat{t}_{\mathcal{D}(\bar{\alpha}, \tilde{n})}(\vec{0}) \leq K^l. \quad (4.10)$$

Therefore, (4.6) implies that

$$|\widehat{\phi}_{\tilde{\mathbf{n}}}^r(\tilde{\mathbf{k}})| \leq \sum_{\bar{\alpha} \in \Sigma_r} \sum_{\tilde{n} \rightsquigarrow \tilde{\mathbf{n}}} K^l \leq \sum_{\bar{\alpha} \in \Sigma_r} \|\tilde{\mathbf{n}}\|_{\infty}^{r-3} K^{2r-4} \leq C_r \|\tilde{\mathbf{n}}\|_{\infty}^{r-3}. \quad (4.11)$$

The second inequality holds since $\sum_{\tilde{n} \rightsquigarrow \tilde{\mathbf{n}}}$ is a sum over at most $r-3$ temporal locations of branch points which are not the origin, each of which must be smaller than $\|\tilde{\mathbf{n}}\|_{\infty}$ by definition. \square

Recall that E_j is the set of edges of the unique path in α from 0 to leaf j . Then $\mathbf{x}_j = \sum_{l=1}^{2r-3} y_l I_{\{l \in E_j\}}$ and

$$\sum_{j=1}^{r-1} \mathbf{k}_j \cdot \mathbf{x}_j = \sum_{j=1}^{r-1} \mathbf{k}_j \cdot \sum_{l=1}^{2r-3} y_l I_{\{l \in E_j\}} = \sum_{l=1}^{2r-3} y_l \cdot \sum_{j=1}^{r-1} \mathbf{k}_j I_{\{l \in E_j\}} = \sum_{l=1}^{2r-3} y_l \cdot \kappa_l = \vec{\kappa} \cdot \vec{y}, \quad (4.12)$$

where κ_l was defined in (1.8). Thus the first term on the right of (4.8) is equal to

$$\sum_{\alpha \in \Sigma_r} \sum_{\tilde{n} \rightsquigarrow \tilde{\mathbf{n}}} \sum_{\tilde{\mathbf{x}}} e^{i\tilde{\mathbf{k}} \cdot \tilde{\mathbf{x}}} \sum_{\vec{y} \rightsquigarrow \tilde{\mathbf{x}}} t_{\mathcal{N}(\alpha, \tilde{n})}(\vec{y}) = \sum_{\alpha \in \Sigma_r} \sum_{\tilde{n} \rightsquigarrow \tilde{\mathbf{n}}} \sum_{\vec{y}} e^{i\vec{\kappa} \cdot \vec{y}} t_{\mathcal{N}(\alpha, \tilde{n})}(\vec{y}) = \sum_{\alpha \in \Sigma_r} \sum_{\tilde{n} \rightsquigarrow \tilde{\mathbf{n}}} \widehat{t}_{\mathcal{N}(\alpha, \tilde{n})}(\vec{\kappa}). \quad (4.13)$$

This becomes clearer if we consider the case $r = 3$, for which there is a unique shape α (which we suppress in the notation for \mathcal{N}), and a single branch point. If we denote the spatial location of the branch point by y then

$$\begin{aligned} \widehat{t}_{(\mathbf{n}_1, \mathbf{n}_2)}^3(\mathbf{k}_1, \mathbf{k}_2) &= \sum_{\mathbf{x}_1, \mathbf{x}_2} \sum_{n=1}^{(\mathbf{n}_1 \wedge \mathbf{n}_2) - 1} e^{i\mathbf{k}_1 \cdot \mathbf{x}_1} e^{i\mathbf{k}_2 \cdot \mathbf{x}_2} \sum_y t_{\mathcal{N}(n, \mathbf{n}_1 - n, \mathbf{n}_2 - n)}(y, \mathbf{x}_1 - y, \mathbf{x}_2 - y) \\ &\quad + \widehat{\phi}_{\tilde{\mathbf{n}}}^3(\tilde{\mathbf{k}}), \end{aligned} \quad (4.14)$$

where informally one may think of $\widehat{\phi}^3$ as consisting of the $n = 0$ and $n = \mathbf{n}_1 \wedge \mathbf{n}_2$ terms missing from the sum over n . The first term on the right of (4.14) is equal to

$$\begin{aligned} & \sum_{n=1}^{(\mathbf{n}_1 \wedge \mathbf{n}_2) - 1} \sum_{\mathbf{x}_1, \mathbf{x}_2} \sum_y e^{i(\mathbf{k}_1 \cdot (\mathbf{x}_1 - y) + \mathbf{k}_2 \cdot (\mathbf{x}_2 - y) + (\mathbf{k}_1 + \mathbf{k}_2) \cdot y)} t_{\mathcal{N}(n, \mathbf{n}_1 - n, \mathbf{n}_2 - n)}(y, \mathbf{x}_1 - y, \mathbf{x}_2 - y) \\ &= \sum_{n=1}^{(\mathbf{n}_1 \wedge \mathbf{n}_2) - 1} \widehat{t}_{\mathcal{N}(n, \mathbf{n}_1 - n, \mathbf{n}_2 - n)}(\kappa_1, \kappa_2, \kappa_3). \end{aligned} \tag{4.15}$$

Recall from (3.2)–(3.3) and the fact that $\zeta_c = 1$, that we were able to express the critical 2-point function as

$$t_n(x) = \sum_{\substack{\omega: o \rightarrow x, \\ |\omega| = n}} W(\omega) \prod_{i=0}^n \sum_{R_i \in \mathcal{T}(\omega(i))} W(R_i) \prod_{0 \leq s < t \leq n} [1 + U_{st}],$$

using the notation $\prod_{i=0}^n \sum_{R_i \in \mathcal{T}(\omega(i))} W(R_i) \prod_{0 \leq s < t \leq n} [1 + U_{st}]$ to represent

$$\sum_{R_0 \in \mathcal{T}(\omega(0))} W(R_0) \cdots \sum_{R_n \in \mathcal{T}(\omega(n))} W(R_n) \prod_{0 \leq s < t \leq n} [1 + U_{st}].$$

The product $\prod [1 + U_{st}]$ incorporates the mutual avoidance of the branches R_i emanating from the backbone ω (which is a random walk), and we analysed this product using the lace expansion. For higher-point functions, the backbone structure in question may be interpreted as a branching random walk, with the temporal (resp. spatial) location and ancestry of the branching given by $\mathcal{N}(\vec{n}, \alpha)$ (resp. \vec{y}).

Definition 4.10. Fix $\mathcal{N}(\vec{n}, \alpha)$. We say that ω is an embedding of \mathcal{N} into \mathbb{Z}^d if ω is a map from the vertex set of \mathcal{N} into \mathbb{Z}^d that maps the root to 0 and adjacent vertices in \mathcal{N} to $D(\cdot)$ neighbours in \mathbb{Z}^d . Let $\Omega_{\mathcal{N}}(\vec{y})$ be the set of embeddings ω of \mathcal{N} into \mathbb{Z}^d such that the embedding ω_i of branch i has displacement y_i .

We now generalise (3.3) to the r -point functions. For a collection of lattice trees $\{R_s\}_{s \in \mathcal{N}}$, define

$$U_{st} = U(R_s, R_t) = \begin{cases} -1, & \text{if } R_s \cap R_t \neq \emptyset \text{ (as sets of vertices)} \\ 0, & \text{otherwise.} \end{cases} \tag{4.16}$$

Recall (Definition 2.1) that $\mathbf{E}_{\mathcal{N}} = \{st : s, t \in \mathcal{N}, s \neq t\}$. Also recall that a vertex $s \in \mathcal{N}$ is uniquely described by a pair (i, m_i) , where i is an edge in α and $m_i \leq n_i$. We write $\prod_{s \in \mathcal{N}} \sum_{R_s \in \mathcal{T}(\omega(s))}$ as shorthand notation for

$$\sum_{R_0 \in \mathcal{T}(\omega(0))} \sum_{R_{(1,1)} \in \mathcal{T}(\omega(1,1))} \sum_{R_{(1,2)} \in \mathcal{T}(\omega(1,2))} \cdots \sum_{R_{(2r-3, n_{2r-3})} \in \mathcal{T}(\omega(2r-3, n_{2r-3}))}.$$

It follows from (4.3) that

$$t_{\mathcal{N}(\alpha, \vec{n})}(\vec{y}) = \sum_{\omega \in \Omega_{\mathcal{N}}(\vec{y})} W(\omega) \prod_{s \in \mathcal{N}} \sum_{R_s \in \mathcal{T}(\omega(s))} W(R_s) \prod_{b \in \mathbf{E}_{\mathcal{N}}} [1 + U_b], \tag{4.17}$$

since any combination $(\omega \in \Omega_{\mathcal{N}}(\vec{y}), \{R_s\}_{s \in \omega})$ such that the R_s are all mutually avoiding lattice trees, uniquely defines a lattice tree $T \in \mathcal{T}_{\mathcal{N}(\alpha, \vec{n})}(\vec{y})$ and vice versa.

4.2 Application of the Lace Expansion

We now apply the expansion described in Section 2.3. Let

$$\phi_{\mathcal{N}}^{\mathcal{R}}(\vec{y}) = \sum_{\omega \in \Omega_{\mathcal{N}}(\vec{y})} W(\omega) \prod_{s \in \mathcal{N}} \sum_{R_s \in \mathcal{T}(\omega(s))} W(R_s) \left(\prod_{b \in \mathcal{R}^c} [1 + U_b] \right) \left(1 - \prod_{b \in \mathcal{R}} [1 + U_b] \right). \quad (4.18)$$

Then by expressions (2.7) and (4.17) we can write

$$t_{\mathcal{N}(\alpha, \vec{n})}(\vec{y}) = \sum_{\omega \in \Omega_{\mathcal{N}}(\vec{y})} W(\omega) \prod_{s \in \mathcal{N}} \sum_{R_s \in \mathcal{T}(\omega(s))} W(R_s) K(\mathcal{N}) - \phi_{\mathcal{N}}^{\mathcal{R}}(\vec{y}), \quad (4.19)$$

where $K(\mathcal{N}) = \prod_{b \in \mathcal{R}^c} [1 + U_b]$. We will see shortly that $\widehat{\phi}_{\mathcal{N}}^{\mathcal{R}}(\vec{\kappa})$ is an error term. Another such error term comes from

$$\phi_{\mathcal{N}}^b(\vec{y}) = \sum_{\omega \in \Omega_{\mathcal{N}}(\vec{y})} W(\omega) \prod_{s \in \mathcal{N}} \sum_{R_s \in \mathcal{T}(\omega(s))} W(R_s) \sum_{\Gamma \in \mathcal{E}_{\mathcal{N}}^b} \prod_{b \in \Gamma} U_b, \quad (4.20)$$

where b is the branch point neighbouring the origin and $\mathcal{E}_{\mathcal{N}}^b$ is defined in part 8 of Definition 2.1.

Recall the definition of a branch from the second paragraph of Section 2.1. Let $\vec{n}_b = (n_1, n_2, n_3)$ be the vector of branch lengths for branches incident to b and let $G = G(\mathcal{N}) \subset \{2, 3\}$ be the set of branch labels for branches incident to b and another branch point of \mathcal{N} . Define $\mathcal{H}_{\vec{n}_b}(\mathcal{N}) \subset \mathbb{Z}_+^3$ and $\overline{\mathcal{H}}_{\vec{n}_b}(\mathcal{N}) \subset \mathbb{Z}_+^3$ by

$$\begin{aligned} \mathcal{H}_{\vec{n}_b} &= \left\{ \vec{m} : 0 \leq m_i \leq \frac{n_i}{3}, \quad i = 1, 2, 3 \right\} \cap \left\{ \vec{m} : m_i \leq n_i - 2, \quad i \in G \right\} \\ \overline{\mathcal{H}}_{\vec{n}_b} &= \left(\left\{ \vec{m} : 0 \leq m_i \leq n_i, \quad i = 1, 2, 3 \right\} \cap \left\{ \vec{m} : m_i \leq n_i - 2, \quad i \in G \right\} \right) \setminus \mathcal{H}_{\vec{n}_b}. \end{aligned} \quad (4.21)$$

Note from (2.17) that $\mathcal{H}_{\vec{n}_b} \cup \overline{\mathcal{H}}_{\vec{n}_b} = \{ \vec{m} : m_1 \leq n_1, m_2 \leq n_2 - 2I_2, m_3 \leq n_3 - 2I_3 \}$ and that this is empty if $n_i = 1$ for some $i \in G$. Equations (2.14)–(2.17) give an expansion for $K(\mathcal{N})$ which yields

$$\begin{aligned} t_{\mathcal{N}}(\vec{y}) &= \sum_{\omega \in \Omega_{\mathcal{N}}(\vec{y})} W(\omega) \prod_{s \in \mathcal{N}} \sum_{R_s \in \mathcal{T}(\omega(s))} W(R_s) \sum_{\vec{m} \in \mathcal{H}_{\vec{n}_b}} J(\mathcal{S}^{\Delta}(\vec{m})) \prod_{i=1}^3 K((\mathcal{N} \setminus \mathcal{S}^{\Delta}(\vec{m}))_i) \\ &\quad + \phi_{\mathcal{N}}^{\pi}(\vec{y}) + \phi_{\mathcal{N}}^b(\vec{y}) - \phi_{\mathcal{N}}^{\mathcal{R}}(\vec{y}), \end{aligned} \quad (4.22)$$

where

$$\phi_{\mathcal{N}}^{\pi}(\vec{y}) \equiv \sum_{\omega \in \Omega_{\mathcal{N}}(\vec{y})} W(\omega) \prod_{s \in \mathcal{N}} \sum_{R_s \in \mathcal{T}(\omega(s))} W(R_s) \sum_{\vec{m} \in \overline{\mathcal{H}}_{\vec{n}_b}} J(\mathcal{S}^{\Delta}(\vec{m})) \prod_{i=1}^3 K((\mathcal{N} \setminus \mathcal{S}^{\Delta}(\vec{m}))_i). \quad (4.23)$$

See Figure 14 for an illustration of these definitions. In accordance with Definition 2.1, the first term on the right side of (4.22) does not contribute in cases where b is adjacent to another branch point of \mathcal{N} (which implies that $r \geq 4$ and $n_2 \wedge n_3 = 1$). For $r = 3$ there is only one branch point, b , hence $\phi_{\mathcal{N}}^b(\vec{y}) = \phi_{\mathcal{N}}^{\mathcal{R}}(\vec{y}) = 0$. Lemma 4.11 below states that in fact for large

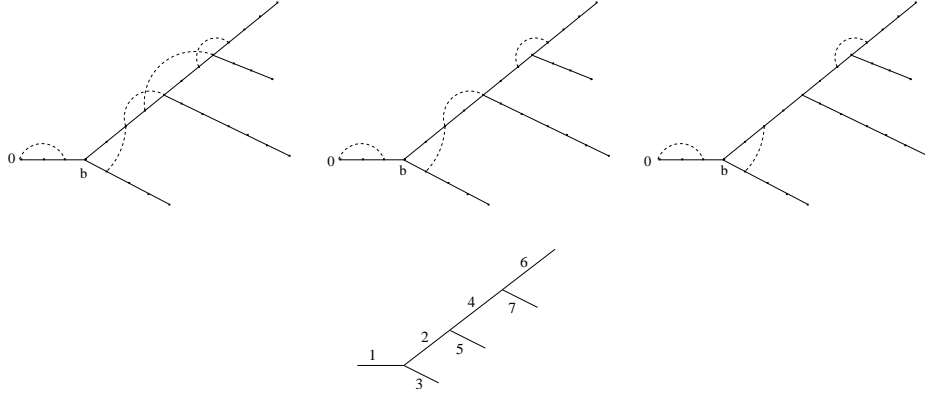

Figure 14: An example of graphs on $\mathcal{N}(\alpha, \vec{n})$ with $\alpha \in \Sigma_5$ a shape with edge labels shown at the bottom and $\vec{n} = (3, 4, 4, 3, 6, 4, 3)$. The first graph contains an edge in \mathcal{R} so contributes to $\phi^{\mathcal{R}}$. The second graph does not contain such an edge but branch 2 is covered so this graph contributes to ϕ^b . In the third graph, branches 2 and 3 are not covered, but $n_2 - 2 \geq m_2 = 2 > \frac{n_2}{3} = \frac{4}{3}$ and this graph contributes to ϕ^π .

$\vec{n}_{-\infty} \equiv \inf_{1 \leq j \leq 2r-3} n_j$, all the terms $\widehat{\phi}_{\mathcal{N}}^{\mathcal{R}}$, $\widehat{\phi}_{\mathcal{N}}^b$ and $\widehat{\phi}_{\mathcal{N}}^\pi$ are error terms, so the main term in (4.22) is

$$Q_{\mathcal{N}(\alpha, \vec{n})}(\vec{y}) = t_{\mathcal{N}(\alpha, \vec{n})}(\vec{y}) - \phi_{\mathcal{N}}^b(\vec{y}) - \phi_{\mathcal{N}}^\pi(\vec{y}) + \phi_{\mathcal{N}}^{\mathcal{R}}(\vec{y}), \quad (4.24)$$

which is the first term on the right of (4.22). Taking Fourier transforms of (4.22) or (4.24) we obtain

$$\widehat{t}_{\mathcal{N}}(\vec{\kappa}) = \widehat{Q}_{\mathcal{N}}(\vec{\kappa}) + \widehat{\phi}_{\mathcal{N}}^b(\vec{\kappa}) + \widehat{\phi}_{\mathcal{N}}^\pi(\vec{\kappa}) - \widehat{\phi}_{\mathcal{N}}^{\mathcal{R}}(\vec{\kappa}). \quad (4.25)$$

Lemma 4.11. *The error terms defined in (4.18), (4.20) and (4.23) satisfy*

$$\sum_{\vec{y}} |\phi_{\mathcal{N}}^{\mathcal{R}}(\vec{y})| = \mathcal{O} \left(\sum_{i=1}^{2r-3} \frac{1}{n_i^{\frac{d-8}{2}}} \right), \quad \sum_{\vec{y}} |\phi_{\mathcal{N}}^b(\vec{y})| = \mathcal{O} \left(\sum_{i=2}^3 \frac{1}{n_i^{\frac{d-8}{2}}} \right), \quad \sum_{\vec{y}} |\phi_{\mathcal{N}}^\pi(\vec{y})| = \mathcal{O} \left(\sum_{i=1}^3 \frac{1}{n_i^{\frac{d-8}{2}}} \right), \quad (4.26)$$

where the constants implied by the \mathcal{O} notation depend on r .

The proof of Lemma 4.11 involves estimating diagrams and is postponed until Section 6.

4.3 Decomposition of $Q_{\mathcal{N}}$

In this section we show that $Q_{\mathcal{N}}$ can be expressed as a convolution of a function $\pi_{\vec{M}}$ and functions $t_{\mathcal{N}_j}$, where the \mathcal{N}_j are network shapes with $\alpha_j \in \Sigma_{r_j}$ and $r_j < r$ for $j = 1, 2, 3$. This permits analysis by induction on r and ultimately we prove that $\widehat{Q}_{\mathcal{N}}$ can be expressed as a Gaussian term plus some error terms.

We first define the quantity $\pi_{\vec{M}}(\vec{u})$ and then the constant V appearing in Theorem 1.14. We then state some bounds on the function $\pi_{\vec{M}}(\vec{u})$ in Proposition 4.13 that are the main ingredient for the proof of Theorem 1.14. The proof of Proposition 4.13 is postponed until Section 6. The

convolution expression for $Q_{\mathcal{N}}(\vec{y})$ appears in Lemma 4.14, and the corresponding expression for the Fourier transform appears in (4.39). Finally we express $\widehat{Q}_{\mathcal{N}}$ as a Gaussian term plus some error terms in (4.40). These error terms are bounded in Section 4.4.

Definition 4.12. *Suppose $\mathcal{S}_{\vec{M}}$ is a star-shaped network of degree $\Delta \in \{1, 3\}$ defined by branch lengths \vec{M} as in (2.18). Let $\vec{u} \in \mathbb{Z}^{\Delta d}$. We define*

$$\pi_{\vec{M}}(\vec{u}) = \sum_{\omega \in \Omega_{\mathcal{S}_{\vec{M}}(\vec{u})}} W(\omega) \prod_{i \in \mathcal{S}_{\vec{M}}} \sum_{R_i \in \mathcal{T}(\omega(i))} W(R_i) J(\mathcal{S}_{\vec{M}}), \quad (4.27)$$

where $\Omega_{\mathcal{S}[-M_i, M_j]}(\vec{u})$ is empty if $u_k \neq 0$ ($k \neq i, j$) and otherwise is the set of embeddings of $\mathcal{S}[-M_i, M_j]$ into \mathbb{Z}^d such that the first, $(M_i + 1)^{\text{st}}$, and last vertices of $\mathcal{S}[-M_i, M_j]$ are mapped to u_i , the origin and u_j respectively. Similarly $\Omega_{\mathcal{S}[0, M_i]}(\vec{u})$ is empty if $u_j \neq 0$ or $u_k \neq 0$ ($j, k \neq i$) and otherwise is the set of embeddings of $\mathcal{S}[0, M_i]$ into \mathbb{Z}^d such that the first and last vertices of $\mathcal{S}[0, M_i]$ are mapped to the origin and u_i respectively. Finally $\Omega_{\mathcal{S}_{\vec{0}}(\vec{u})}$ is empty if any $u_i \neq 0$ and otherwise is the map of the single vertex $\mathcal{S}_{\vec{0}}$ to the origin (whence $\pi_{\vec{0}}(\vec{u}) = \rho(o) I_{\{\vec{u}=\vec{0}\}}$).

By (2.10) we can write

$$\begin{aligned} J(\mathcal{S}_{\vec{M}}^{\Delta}) &= \sum_{N=1}^{\infty} \sum_{L \in \mathcal{L}^N(\mathcal{S}_{\vec{M}}^{\Delta})} \prod_{b \in L} U_b \prod_{b' \in \mathcal{C}(L)} [1 + U_{b'}] \\ &= \sum_{N=1}^{\infty} (-1)^N \sum_{L \in \mathcal{L}^N(\mathcal{S}_{\vec{M}}^{\Delta})} \prod_{b \in L} (-U_b) \prod_{b' \in \mathcal{C}(L)} [1 + U_{b'}], \end{aligned} \quad (4.28)$$

so that for $\vec{M} \neq \vec{0}$, $\pi_{\vec{M}}(\vec{u}) = \sum_{N=1}^{\infty} (-1)^N \pi_{\vec{M}}^N(\vec{u})$ where

$$\pi_{\vec{M}}^N(\vec{u}) \equiv \sum_{L \in \mathcal{L}^N(\mathcal{S}_{\vec{M}}^{\Delta})} \sum_{\omega \in \Omega_{\mathcal{S}_{\vec{M}}^{\Delta}}(\vec{u})} W(\omega) \prod_{i \in \mathcal{S}_{\vec{M}}^{\Delta}} \sum_{R_i \in \mathcal{T}(\omega(i))} W(R_i) \prod_{b \in L} (-U_b) \prod_{b' \in \mathcal{C}(L)} [1 + U_{b'}]. \quad (4.29)$$

Note that $\pi_{\vec{M}}^N(\vec{u}) \geq 0$ since $-U_b \geq 0$. We also define

$$V \equiv \sum_{\vec{M} \in \mathbb{Z}_+^3} \sum_{\vec{u} \in \mathbb{Z}^{3d}} \sum_{\vec{v} \in \mathbb{Z}^{3d}} \pi_{\vec{M}}(\vec{v}) \prod_{i=1}^3 p_c D(u_i - v_i) = p_c^3 \sum_{\vec{M}} \sum_{\vec{v}} \pi_{\vec{M}}(\vec{v}). \quad (4.30)$$

The following Proposition is proved in Section 6 and is the main ingredient for the proof of Theorem 4.8.

Proposition 4.13. *There exist $C > 0$ (independent of L) and $B_N(\vec{M})$ such that for $N \geq 1$ and $q \in \{0, 1\}$,*

$$\sum_{\vec{u} \in \mathbb{Z}^{3d}} |u_j|^{2q} \pi_{\vec{M}}^N(\vec{u}) \leq (N^2 \sigma^2 \|\vec{M}\|_{\infty})^q B_N(\vec{M}), \quad (4.31)$$

where $\vec{u} = (u_1, u_2, u_3)$,

$$\begin{aligned} \sum_{N=1}^{\infty} \sum_{\vec{M}: M_j \geq n_j} B_N(\vec{M}) &\leq \frac{(C\beta^{2-\frac{8\nu}{d}})^{1/2}}{[n_j]^{\frac{d-8}{2}}}, \quad j = 1, 2, 3, \quad \text{and} \\ \sum_{N=1}^{\infty} N^2 \sum_{\vec{M} \leq \vec{n}} \|\vec{M}\|_{\infty} B_N(\vec{M}) &\leq C \begin{cases} \|\vec{n}\|_{\infty}^{\frac{10-d}{2} \vee 0}, & \text{if } d \neq 10 \\ \log \|\vec{n}\|_{\infty}, & \text{if } d = 10. \end{cases} \end{aligned} \quad (4.32)$$

Given $\vec{M} \in \mathcal{H}_{\vec{n}_b}$ (such that $\mathcal{S}_{\vec{M}} \subset \mathcal{N}$), $\vec{y} \in \mathbb{Z}^{(2r-3)d}$ and $\vec{v} \in \mathbb{Z}^{3d}$ we define $\mathcal{N}_i^- = \mathcal{N}_i^-(\vec{M}) = (\mathcal{N} \setminus \mathcal{S}_{\vec{M}})_i$ (see Definition 2.10). We write $\mathcal{B}_{\mathcal{N}_i^-}$ for the set of labels of branches in $\mathcal{N}_i^- \subset \mathcal{N}$ that were not incident to the branchpoint b neighbouring the root in \mathcal{N} , and \vec{y}_i for the vector of y_j such that $j \in \mathcal{B}_{\mathcal{N}_i^-}$. Then we define

$$\vec{y}_{v_i} = (y_i - v_i, \vec{y}_i). \quad (4.33)$$

Lemma 4.14. For $\vec{y} \in \mathbb{Z}^{(2r-3)d}$ and $\vec{n} \in \mathbb{N}^{2r-3}$,

$$Q_{\mathcal{N}(\alpha, \vec{n})}(\vec{y}) = \sum_{\vec{M} \in \mathcal{H}_{\vec{n}_b}} \sum_{\vec{u}} \pi_{\vec{M}}(\vec{u}) \prod_{i=1}^3 p_c \sum_{v_i} D(v_i - u_i) t_{\mathcal{N}_i^-}(\vec{y}_{v_i}). \quad (4.34)$$

Proof. First from (4.22) and (4.24) we have

$$Q_{\mathcal{N}(\alpha, \vec{n})}(\vec{y}) = \sum_{\vec{M} \in \mathcal{H}_{\vec{n}_b}} \sum_{\omega \in \Omega_{\mathcal{N}}(\vec{y})} W(\omega) \prod_{s \in \mathcal{N}} \sum_{R_s \in \mathcal{T}(\omega(s))} W(R_s) J(\mathcal{S}^{\Delta}(\vec{M})) \prod_{i=1}^3 K(\mathcal{N}_i^-). \quad (4.35)$$

However, as in the proof of (3.6) for the two point function, we may split up the branching random walk $\omega \in \Omega_{\mathcal{N}}(\vec{y})$ into 4 branching random walks (some of which may be empty) to obtain

$$\sum_{\omega \in \Omega_{\mathcal{N}}(\vec{y})} W(\omega) = \sum_{\vec{u}} \sum_{\omega \in \Omega_{\mathcal{S}_{\vec{M}}(\vec{u})}} W(\omega) \prod_{i=1}^3 \sum_{v_i} p_c D(v_i - u_i) \sum_{\omega_i \in \Omega_{\mathcal{N}_i^-}(\vec{y}_{v_i})} W(\omega_i). \quad (4.36)$$

Trivially,

$$\prod_{s \in \mathcal{N}} \sum_{R_s \in \mathcal{T}(\omega(s))} W(R_s) = \prod_{s \in \mathcal{S}_{\vec{M}}} \sum_{R_s \in \mathcal{T}(\omega(s))} W(R_s) \prod_{i=1}^3 \prod_{s_i \in \mathcal{N}_i^-} \sum_{R_{s_i} \in \mathcal{T}(\omega_i(s_i))} W(R_{s_i}), \quad (4.37)$$

where the products of the form $s \in \mathcal{N}^-$ are products over vertices in the network shape \mathcal{N}^- . Since by definition, \mathcal{N}_i^- and $\mathcal{S}_{\vec{M}}$ are vertex disjoint (i.e. have no vertex in common), equations

(4.35)–(4.37) show that $Q_{\mathcal{N}(\alpha, \vec{n})}(\vec{y})$ is equal to

$$\begin{aligned}
& \left(\sum_{\vec{M} \in \mathcal{H}_{\vec{n}_b}} \sum_{\vec{u}} \sum_{\omega \in \Omega_{\mathcal{S}_{\vec{M}}(\vec{u})}} W(\omega) \prod_{s \in \mathcal{S}_{\vec{M}}} \sum_{R_s \in \mathcal{T}(\omega(s))} W(R_s) J(\mathcal{S}_{\vec{M}}) \right) \times \\
& \left(\prod_{i=1}^3 \sum_{v_i} p_c D(v_i - u_i) \sum_{\omega_i \in \Omega_{\mathcal{N}_i^-}(\vec{y}_{v_i})} W(\omega_i) \prod_{s_i \in \mathcal{N}_i} \sum_{R_{s_i} \in \mathcal{T}(\omega_i(s_i))} W(R_{s_i}) K(\mathcal{N}_i^-) \right) \\
& = \sum_{\vec{M} \in \mathcal{H}_{\vec{n}_b}} \sum_{\vec{u}} \pi_{\vec{M}}(\vec{u}) \prod_{i=1}^3 p_c \sum_{v_i} D(v_i - u_i) t_{\mathcal{N}_i^-}(\vec{y}_{v_i}),
\end{aligned} \tag{4.38}$$

as required. \square

Given $\vec{\kappa} \in [-\pi, \pi]^{2r-3}$ we let $\vec{\kappa}^b = (\kappa_1, \kappa_2, \kappa_3)$, and $\vec{\kappa}_j^*$ denote the vector of κ_i , for branches i of \mathcal{N}_j^- (labels inherited from \mathcal{N}). Then

$$e^{i\vec{\kappa} \cdot \vec{y}} = e^{i\vec{\kappa}^b \cdot \vec{u}} \prod_{j=1}^3 e^{i\kappa_j \cdot (v_j - u_j)} e^{i\vec{\kappa}_j^* \cdot \vec{y}_{v_j}}.$$

It follows from Lemma 4.14 that

$$\widehat{Q}_{\mathcal{N}}(\vec{\kappa}) = \sum_{\vec{M} \in \mathcal{H}_{\vec{n}_b}} \widehat{\pi}_{\vec{M}}(\vec{\kappa}^b) \prod_{j=1}^3 p_c \widehat{D}(\kappa_j) \widehat{t}_{\mathcal{N}_j}(\vec{\kappa}_j^*). \tag{4.39}$$

Finally, recall (3.49), (4.30), and the fact that $A = A' \rho(0)$. We write

$$\widehat{Q}_{\mathcal{N}}(\vec{\kappa}) = V^{r-2} \prod_{i=1}^{2r-3} A e^{-\frac{\kappa_i^2}{2d} n_i \sigma^2 v} + \mathcal{E}_{\vec{n}}^D(\vec{\kappa}) + \mathcal{E}_{\vec{n}}^{\vec{0}}(\vec{\kappa}) + \mathcal{E}_{\vec{n}}^{\text{ind}}(\vec{\kappa}) + \mathcal{E}_{\vec{n}}^V(\vec{\kappa}), \tag{4.40}$$

where the $\mathcal{E}_{\vec{n}}^i$ are defined by

$$\begin{aligned}
\mathcal{E}_{\vec{n}}^D(\vec{\kappa}) &\equiv \sum_{\substack{E \subset \{1,2,3\} \\ E \neq \emptyset}} \left(\prod_{l \in E} (\widehat{D}(\kappa_l) - 1) \right) p_c^3 \sum_{\vec{M} \in \mathcal{H}_{\vec{n}_b}} \widehat{\pi}_{\vec{M}}(\vec{\kappa}^b) \prod_{j=1}^3 \widehat{t}_{\mathcal{N}_j}(\vec{\kappa}_j^*), \\
\mathcal{E}_{\vec{n}}^{\vec{0}}(\vec{\kappa}) &= p_c^3 \sum_{\vec{M} \in \mathcal{H}_{\vec{n}_b}} \left(\widehat{\pi}_{\vec{M}}(\vec{\kappa}^b) - \widehat{\pi}_{\vec{M}}(\vec{0}) \right) \prod_{j=1}^3 \widehat{t}_{\mathcal{N}_j}(\vec{\kappa}_j^*), \\
\mathcal{E}_{\vec{n}}^{\text{ind}}(\vec{\kappa}) &= p_c^3 \sum_{\vec{M} \in \mathcal{H}_{\vec{n}_b}} \widehat{\pi}_{\vec{M}}(\vec{0}) \left(\prod_{j=1}^3 \widehat{t}_{\mathcal{N}_j^-}(\vec{\kappa}_j^*) - V^{r-3} \prod_{l=1}^{2r-3} A e^{-\frac{\kappa_l^2}{2d} n_l \sigma^2 v} \right), \\
\mathcal{E}_{\vec{n}}^V(\vec{\kappa}) &= V^{r-3} \prod_{l=1}^{2r-3} A e^{-\frac{\kappa_l^2}{2d} n_l \sigma^2 v} p_c^3 \sum_{\vec{M} \notin \mathcal{H}_{\vec{n}_b}} \widehat{\pi}_{\vec{M}}(\vec{0}).
\end{aligned} \tag{4.41}$$

The first term is obtained by writing $\widehat{D}(\kappa_j) = (1 + (\widehat{D}(\kappa_j) - 1))$, the second is obtained by writing $\widehat{\pi}_{\vec{M}}(\vec{\kappa}^b) = (\widehat{\pi}_{\vec{M}}(\vec{0}) + (\widehat{\pi}_{\vec{M}}(\vec{\kappa}^b) - \widehat{\pi}_{\vec{M}}(\vec{0})))$ and so on.

4.4 Bounds on the \mathcal{E} .

In this section we prove bounds on the quantities (4.41), as stated in Lemma 4.15. All of these terms will turn out to be error terms in our analysis and in general rely on estimates for $\widehat{\pi}_{\vec{M}}(\vec{\kappa})$ such as those appearing in Proposition 4.13. Each term except \mathcal{E}^{ind} will also use naive bounds of the form appearing in (4.4).

Using (4.32) with $n_j = 1$,

$$\sum_{\vec{M} \neq \vec{0}} |\widehat{\pi}_{\vec{M}}(\vec{\kappa}^b)| = \sum_{N=1}^{\infty} \sum_{\vec{M} \neq \vec{0}} \sum_{\vec{u}} \pi_{\vec{M}}^N(\vec{u}) \leq \sum_N \sum_{\vec{M}} B_N(\vec{M}) \leq (C\beta^{2-\frac{8\nu}{d}})^{\frac{1}{2}}, \quad (4.42)$$

where the constant C is independent of L . In particular since $\widehat{\pi}_{\vec{0}}(\vec{0}) = \rho(o)$, this proves that $V = \rho(o)p_c^3 + \mathcal{O}(\beta^{2-\frac{8\nu}{d}})$.

Lemma 4.15 ($\mathcal{E}_{\vec{n}}^{\bullet}$ bounds). *For all $\vec{\kappa}$,*

$$\mathcal{E}_{\vec{n}}^D(\vec{\kappa}) = \mathcal{O}\left(L^2 \sum_{j=1}^3 \kappa_j^2\right), \quad \mathcal{E}_{\vec{n}}^V(\vec{\kappa}) = \mathcal{O}\left(\sum_{j=1}^3 \frac{1}{n_j^{\frac{d-8}{2}}}\right) \quad (4.43)$$

$$\mathcal{E}_{\vec{n}}^{\vec{0}}(\vec{\kappa}) = \begin{cases} \mathcal{O}\left(|\vec{\kappa}^b|^2 \sigma^2 \|\vec{n}^b\|_{\infty}^{\left(\frac{10-d}{2} \vee 0\right)}\right), & \text{if } d \neq 10 \\ \mathcal{O}\left(|\vec{\kappa}^b|^2 \sigma^2 \log \|\vec{n}\|_{\infty}\right), & \text{if } d = 10, \end{cases} \quad (4.44)$$

Proof. For $l \notin E$ we bound $\prod_{j=1}^3 \widehat{t}_{N_j}(\vec{\kappa}_j^*)$ and $\sum_{\vec{M}} \widehat{\pi}_{\vec{M}}(\vec{\kappa}^b)$ by constants using (4.4) and (4.42). This leaves us with

$$|\mathcal{E}_{\vec{n}}^D(\vec{\kappa})| \leq C \sum_{\substack{E \subset \{1,2,3\} \\ E \neq \emptyset}} \prod_{j \in E} a(\kappa_j).$$

For each nonempty E we may bound all but one of the $a(\kappa_i)$ by 2, giving $|\mathcal{E}_{\vec{n}}^D(\vec{\kappa})| \leq C \sum_{j=1}^3 a(\kappa_j)$. In particular since $a(\kappa_j) \leq 2$ this quantity is also bounded by a constant C' . If $\|\kappa_j\|_{\infty} \geq L^{-1}$, then there exists a constant $c > 0$ depending only on C' such that $C' \leq c \|\vec{\kappa}^b\|^2 L^2$ as required. If $\|\kappa_j\|_{\infty} \leq L^{-1}$, this bound is obtained from (3.20). This proves the first claim of the Lemma.

For the second claim, we bound each exponential in the definition of \mathcal{E}^V (4.41) by a constant, leaving

$$|\mathcal{E}_{\vec{n}}^V(\vec{\kappa})| \leq C \sum_{\vec{M} \notin \mathcal{H}_{\vec{n}^b}} |\widehat{\pi}_{\vec{M}}(\vec{0})|.$$

Next we observe that $\vec{M} \in \mathcal{H}_{\vec{n}^b}$ only if $M_j \geq \frac{n_j}{3}$ for some $j \in \{1, 2, 3\}$, or $n_j \leq 2$ for some j . In the latter case, the required bound is trivial, while in the former case it follows from Proposition 4.13.

For the last claim, we bound the $\widehat{t}_{\mathcal{N}_j}$ by a constant and apply (3.31) (with $3d$ rather than d) with $\vec{\kappa}^b = (\kappa_{1,1}, \dots, \kappa_{1,d}, \kappa_{2,1}, \dots, \kappa_{2,d}, \kappa_{3,1}, \dots, \kappa_{3,d})$ to bound the difference $\widehat{\pi}_{\vec{M}}(\vec{0}) - \widehat{\pi}_{\vec{M}}(\vec{\kappa}^b)$. In doing so we obtain

$$\left| \widehat{\pi}_{\vec{M}}(\vec{0}) - \widehat{\pi}_{\vec{M}}(\vec{\kappa}^b) \right| \leq C |\vec{\kappa}^b|^2 \sum_{\vec{u} \in \mathbb{Z}^{3d}} |u_j|^2 |\widehat{\pi}_{\vec{M}}(\vec{u})|. \quad (4.45)$$

This gives us

$$|\mathcal{E}_{\vec{n}}^{\vec{0}}(\vec{\kappa})| \leq C \sum_{\vec{M} \leq \vec{n}^b} |\vec{\kappa}^b|^2 \sum_{\vec{u} \in \mathbb{Z}^{3d}} |u_j|^2 |\widehat{\pi}_{\vec{M}}(\vec{u})|. \quad (4.46)$$

Applying Proposition 4.13 we obtain

$$\left| \mathcal{E}_{\vec{n}}^{\vec{0}}(\vec{\kappa}) \right| \leq C \sum_{\vec{M} \leq \vec{n}^b} |\vec{\kappa}|^2 \sigma^2 \|\vec{M}\|_{\infty} N^2 B_N(\vec{M}) \leq C \beta^{2 - \frac{8\nu}{d}} \begin{cases} |\vec{\kappa}^b|^2 \sigma^2 \|\vec{n}^b\|_{\infty}^{\left(\frac{10-d}{2} \vee 0\right)} & \text{if } d \neq 10 \\ |\vec{\kappa}^b|^2 \sigma^2 \log \|\vec{n}^b\|_{\infty}, & \text{if } d = 10, \end{cases} \quad (4.47)$$

as required. \square

It follows immediately from Lemma 4.15 that

$$\mathcal{E}_{\vec{n}}^D(\vec{\kappa}) \left(\frac{\vec{\kappa}}{\sqrt{v\sigma^2 n}} \right) = \mathcal{O} \left(\frac{L^2 \sum_{j=1}^3 \kappa_j^2}{\sigma^2 n} \right) = \mathcal{O} \left(\frac{\sum_{j=1}^3 \kappa_j^2}{n} \right), \quad (4.48)$$

and

$$\mathcal{E}_{\vec{n}}^{\vec{0}} \left(\frac{\vec{\kappa}}{\sqrt{v\sigma^2 n}} \right) = \begin{cases} \mathcal{O} \left(\frac{|\vec{\kappa}^b|^2 \|\vec{n}^b\|_{\infty}^{\left(\frac{10-d}{2} \vee 0\right)}}{vn} \right), & \text{if } d \neq 10, \\ \mathcal{O} \left(\frac{|\vec{\kappa}^b|^2 \log \|\vec{n}^b\|_{\infty}}{vn} \right), & \text{if } d = 10. \end{cases} \quad (4.49)$$

4.5 Proof of Theorem 4.8.

We prove Theorem 4.8 by induction on r (or equivalently on the number of branches $2r - 3$ in \mathcal{N}). For $r = 2$ recall that $A = A' \rho(o)$, so (as in the proof of Theorem 1.12) we have by Theorem 3.7 and Lemma 3.9 that

$$\widehat{t}_{n_1} \left(\frac{\kappa}{\sqrt{v\sigma^2 n}} \right) = A e^{-\frac{\kappa^2}{2d} \frac{n_1}{n}} + \mathcal{O} \left(\frac{\kappa^2 \frac{n_1}{n}}{n_1^{\delta}} \right) + \mathcal{O} \left(\frac{1}{n_1^{\frac{d-8}{2}}} \right), \quad (4.50)$$

with the error terms uniform in $\{\kappa \in \mathbb{R}^d : |\kappa|^2 \leq C_0 \log n_1\}$. This yields the required result for $r = 2$.

Now fix r and $\mathcal{N} = \mathcal{N}(\alpha, \vec{n})$ with $\alpha \in \Sigma_r$ and $\vec{n} \in \mathbb{N}^{2r-3}$, and assume the theorem holds for all $r_i < r$. By (4.25) and Lemma 4.11, we have that

$$\widehat{t}_{\mathcal{N}} \left(\frac{\vec{\kappa}}{\sqrt{v\sigma^2 n}} \right) = \widehat{Q}_{\mathcal{N}} \left(\frac{\vec{\kappa}}{\sqrt{v\sigma^2 n}} \right) + \mathcal{O} \left(\sum_{l=1}^{2r-3} \frac{1}{n_l^{\frac{d-8}{2}}} \right).$$

Next from (4.40), (4.48)–(4.49) and (4.43), we have that $\widehat{Q}_{\mathcal{N}}\left(\frac{\vec{\kappa}}{\sqrt{v\sigma^2n}}\right)$ is equal to $V^{r-2}\prod_{l=1}^{2r-3}Ae^{-\frac{\kappa_l^2n_l}{2d}}n$ plus the error term (4.49) plus

$$\mathcal{E}_{\vec{n}}^{\text{ind}}\left(\frac{\vec{\kappa}}{\sqrt{v\sigma^2n}}\right) + \mathcal{O}\left(\frac{\sum_{j=1}^3\kappa_j^2}{n}\right) + \mathcal{O}\left(\sum_{j=1}^3\frac{1}{n_j^{\frac{d-8}{2}}}\right).$$

Since $\delta < \frac{d-8}{2} \wedge 1$ in the statement of Theorem 4.8 we have $\frac{10-d}{2} \vee 0 < 1 - \delta$ and these error terms satisfy the error bounds of the Theorem. It therefore remains to show that $\mathcal{E}_{\vec{n}}^{\text{ind}}\left(\frac{\vec{\kappa}}{\sqrt{v\sigma^2n}}\right)$ is an error term of the required type.

From (4.41) we have

$$\mathcal{E}_{\vec{n}}^{\text{ind}}\left(\frac{\vec{\kappa}}{\sqrt{v\sigma^2n}}\right) = p_c^3 \sum_{\vec{M} \in \mathcal{H}_{\vec{n}_b}} \widehat{\pi}_{\vec{M}}(\vec{0}) \left(\prod_{j=1}^3 \widehat{t}_{\mathcal{N}_j^-} \left(\frac{\vec{\kappa}_j^*}{\sqrt{v\sigma^2n}} \right) - V^{r-3} \prod_{l=1}^{2r-3} Ae^{-\frac{\kappa_l^2n_l}{2dn}} \right). \quad (4.51)$$

If $\mathcal{H}_{\vec{n}_b} = \emptyset$ then $\mathcal{E}_{\vec{n}}^{\text{ind}} = 0$. By the induction hypothesis applied to $r_j < r$, we have

$$\widehat{t}_{\mathcal{N}_j^-} \left(\frac{\vec{\kappa}_j^*}{\sqrt{v\sigma^2n}} \right) = V^{r_j-2} A^{2r_j-3} \prod_{l \in \mathcal{B}_{\mathcal{N}_j^-}} e^{-\frac{\kappa_{jl}^2 n_{jl}^*}{2dn}} + \mathcal{O}\left(\sum_{l \in \mathcal{B}_{\mathcal{N}_j^-}} \frac{1}{n_{jl}^{\frac{d-8}{2}}}\right) + \mathcal{O}\left(\sum_{l \in \mathcal{B}_{\mathcal{N}_j^-}} \frac{|\vec{\kappa}_j^*|^2 n_{jl}^{*(1-\delta)}}{n}\right), \quad (4.52)$$

where the sums and products are over branch labels of branches in \mathcal{N}_j^- . For $\vec{M} \in \mathcal{H}_{\vec{n}_b}$, for every $j \in \{1, 2, 3\}$ we have $\frac{2n_l}{3} \leq n_{jl} \leq n_l$. This enables us to replace n_{jl} by n_l if necessary in the error terms of (4.52). Additionally since $\vec{M} \in \mathcal{H}_{\vec{n}_b}$ we have $r = \sum_{i=1}^3(r_i - 1)$, or equivalently $\sum_{i=1}^3 r_i = r + 3$ (see Figure 15) and

$$\prod_{j=1}^3 \widehat{t}_{\mathcal{N}_j^-} \left(\frac{\vec{\kappa}_j^*}{\sqrt{v\sigma^2n}} \right) = V^{r-3} A^{2r-3} \prod_{l=4}^{2r-3} e^{-\frac{\kappa_l^2 n_l}{2dn}} \prod_{j=1}^3 e^{-\frac{\kappa_j^2 (n_j - M_j)}{2dn}} + \mathcal{O}\left(\sum_{l=1}^{2r-3} \frac{1}{n_l^{\frac{d-8}{2}}}\right) + \mathcal{O}\left(\sum_{l=1}^{2r-3} \frac{|\vec{\kappa}|^2 n_l^{(1-\delta)}}{n}\right). \quad (4.53)$$

Thus, $\prod_{j=1}^3 \widehat{t}_{\mathcal{N}_j^-} \left(\frac{\vec{\kappa}_j^*}{\sqrt{v\sigma^2n}} \right) - V^{r-3} \prod_{l=1}^{2r-3} Ae^{-\frac{\kappa_l^2 n_l}{2dn}}$ is equal to

$$V^{r-3} A^{2r-3} \prod_{l=4}^{2r-3} e^{-\frac{\kappa_l^2 n_l}{2dn}} \left[\prod_{j=1}^3 e^{-\frac{\kappa_j^2 (n_j - M_j)}{2dn}} - \prod_{j=1}^3 e^{-\frac{\kappa_j^2 n_j}{2dn}} \right] + \mathcal{O}\left(\sum_{l=1}^{2r-3} \frac{1}{n_l^{\frac{d-8}{2}}}\right) + \mathcal{O}\left(\sum_{l=1}^{2r-3} \frac{|\vec{\kappa}|^2 n_l^{(1-\delta)}}{n}\right). \quad (4.54)$$

Next using a telescoping sum and the inequality $e^{-a} - e^{-b} \leq C(b - a)$ for $b \geq a \geq 0$ we see that

$$\begin{aligned} \left[\prod_{j=1}^3 e^{-\frac{\kappa_j^2 (n_j - M_j)}{2dn}} - \prod_{j=1}^3 e^{-\frac{\kappa_j^2 n_j}{2dn}} \right] &= \sum_{l=1}^3 \left(\prod_{j < l} e^{-\frac{\kappa_j^2 n_j}{2dn}} \right) \left[e^{-\frac{\kappa_l^2 (n_l - M_l)}{2dn}} - e^{-\frac{\kappa_l^2 n_l}{2dn}} \right] \left(\prod_{j > l} e^{-\frac{\kappa_j^2 (n_j - M_j)}{2dn}} \right) \\ &\leq C \sum_{l=1}^3 \frac{\kappa_l^2}{2dn} [n_l - (n_l - M_l)] = C \sum_{l=1}^3 \frac{\kappa_l^2 M_l}{2dn}. \end{aligned} \quad (4.55)$$

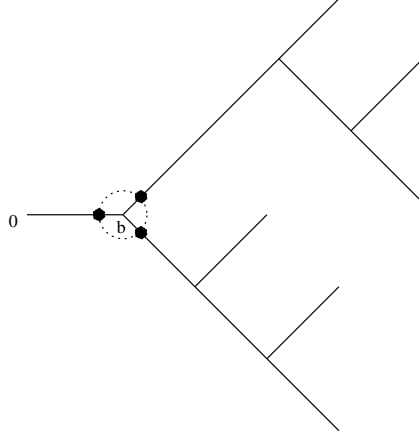

Figure 15: An illustration of the relation $\sum_{i=1}^3 r_i = r + 3$ resulting from the decomposition of a network \mathcal{N} into \mathcal{N}_i , when $\vec{M} \in \mathcal{H}_{\vec{n}_b}$. The 3 extra vertices generated by this decomposition are indicated.

Collecting terms and applying Proposition 4.13 we have

$$\begin{aligned}
\left| \mathcal{E}_{\vec{n}}^{\text{ind}} \left(\frac{\vec{\kappa}}{\sqrt{v\sigma^2 n}} \right) \right| &\leq p_c^3 \sum_{l=1}^3 \frac{\kappa_l^2}{2dn} \sum_N \sum_{\vec{M} \in \mathcal{H}_{\vec{n}_b}} \hat{\pi}_{\vec{M}}^N(\vec{0}) M_l + \mathcal{O} \left(\sum_{l=1}^{2r-3} \frac{1}{n_l^{\frac{d-8}{2}}} \right) + \mathcal{O} \left(\sum_{l=1}^{2r-3} \frac{|\vec{\kappa}|^2 n_l^{(1-\delta)}}{n} \right) \\
&= \mathcal{O} \left(\sum_{l=1}^3 \frac{|\vec{\kappa}|^2 n_l^{\frac{10-d}{2} \vee 0}}{n} \right) + \mathcal{O} \left(\sum_{l=1}^{2r-3} \frac{1}{n_l^{\frac{d-8}{2}}} \right) + \mathcal{O} \left(\sum_{l=1}^{2r-3} \frac{|\vec{\kappa}|^2 n_l^{(1-\delta)}}{n} \right).
\end{aligned} \tag{4.56}$$

Since $1 - \delta > \frac{10-d}{2} \vee 0$ these are all error terms of the required form. We have now advanced the induction hypothesis and therefore completed the proof of the theorem. \square

4.6 Proof of Theorem 1.14.

From (4.8) and Lemma 4.9 we have

$$\begin{aligned}
\hat{t}_{[n\tilde{\mathbf{t}}]}^{(r)} \left(\frac{\tilde{\mathbf{k}}}{\sqrt{\sigma^2 v n}} \right) &= \sum_{\alpha \in \Sigma_r} \sum_{\vec{n} \rightsquigarrow [n\tilde{\mathbf{t}}]} \hat{t}_{\mathcal{N}(\alpha, \vec{n})} \left(\frac{\vec{\kappa}}{\sqrt{\sigma^2 v n}} \right) + \hat{\phi}_{[n\tilde{\mathbf{t}}]}^r \left(\frac{\tilde{\mathbf{k}}}{\sqrt{\sigma^2 v n}} \right) \\
&= \sum_{\alpha \in \Sigma_r} \sum_{\vec{n} \rightsquigarrow [n\tilde{\mathbf{t}}]} \hat{t}_{\mathcal{N}(\alpha, \vec{n})} \left(\frac{\vec{\kappa}}{\sqrt{\sigma^2 v n}} \right) + n^{r-2} \mathcal{O} \left(\frac{\|\tilde{\mathbf{t}}\|_{\infty}^{r-3}}{n} \right),
\end{aligned} \tag{4.57}$$

with $\vec{\kappa} = \vec{\kappa}(\alpha, \tilde{\mathbf{k}})$ as defined in (1.8). Theorem 4.8 may be applied to the first term, giving

$$\begin{aligned} \widehat{t}_{[n\tilde{\mathbf{t}}]}^{(r)} \left(\frac{\tilde{\mathbf{k}}}{\sqrt{\sigma^2 v n}} \right) &= \sum_{\alpha \in \Sigma_r} \sum_{\substack{\vec{n} \rightsquigarrow [n\tilde{\mathbf{t}}]: \\ \vec{n} \in \mathbb{N}^{2r-3}}} \left[V^{r-2} A^{2r-3} \prod_{j=1}^{2r-3} e^{-\frac{\kappa_j^2}{2d} \binom{n_j}{n}} + \mathcal{O} \left(\sum_{j=1}^{2r-3} \frac{1}{n_j^{\frac{d-8}{2}}} \right) + \mathcal{O} \left(\sum_{j=1}^{2r-3} \frac{|\vec{\kappa}|^2 n_j^{1-\delta}}{n} \right) \right] \\ &\quad + n^{r-2} \mathcal{O} \left(\frac{\|\tilde{\mathbf{t}}\|_\infty^{r-3}}{n} \right). \end{aligned} \quad (4.58)$$

Considering the first error term, note that

$$\begin{aligned} \sum_{\vec{n} \rightsquigarrow [n\tilde{\mathbf{t}}]} \frac{1}{n_j^{\frac{d-8}{2}}} &= \sum_{\substack{\vec{n} \rightsquigarrow [n\tilde{\mathbf{t}}]: \\ n_j \leq \frac{\|n\tilde{\mathbf{t}}\|_\infty}{2}}} \frac{1}{n_j^{\frac{d-8}{2}}} + \sum_{\substack{\vec{n} \rightsquigarrow [n\tilde{\mathbf{t}}]: \\ n_j > \frac{\|n\tilde{\mathbf{t}}\|_\infty}{2}}} \frac{1}{n_j^{\frac{d-8}{2}}} \leq \sum_{m \leq \frac{\|n\tilde{\mathbf{t}}\|_\infty}{2}} \sum_{\substack{\vec{n} \rightsquigarrow [n\tilde{\mathbf{t}}]: \\ n_j = m}} \frac{1}{n_j^{\frac{d-8}{2}}} + \frac{C}{\|n\tilde{\mathbf{t}}\|_\infty^{\frac{d-8}{2}}} \sum_{\substack{\vec{n} \rightsquigarrow [n\tilde{\mathbf{t}}]: \\ n_j > \frac{\|n\tilde{\mathbf{t}}\|_\infty}{2}}} 1 \\ &\leq \sum_{m \leq \frac{\|n\tilde{\mathbf{t}}\|_\infty}{2}} \frac{1}{m^{\frac{d-8}{2}}} \sum_{\substack{\vec{n} \rightsquigarrow [n\tilde{\mathbf{t}}]: \\ n_j = m}} 1 + \|n\tilde{\mathbf{t}}\|_\infty^{r-2-\frac{d-8}{2}} \leq C \|n\tilde{\mathbf{t}}\|_\infty^{(\frac{10-d}{2} \vee 0)} \|n\tilde{\mathbf{t}}\|_\infty^{r-3} + \|n\tilde{\mathbf{t}}\|_\infty^{r-2-\frac{d-8}{2}}, \end{aligned} \quad (4.59)$$

where if $d = 10$ we interpret the quantity $\|n\tilde{\mathbf{t}}\|_\infty^{(\frac{10-d}{2} \vee 0)}$ as $\log(\lfloor n\tilde{\mathbf{t}} \rfloor)$. In the last step we used the fact that since $\lfloor n\tilde{\mathbf{t}} \rfloor$ is fixed, the sum over $\vec{n} \rightsquigarrow [n\tilde{\mathbf{t}}] : n_j = m$ is a sum over temporal locations of $r - 3$ branch points. Since $|\Sigma_r|$ is a finite quantity depending only on r , the first error term in (4.58) is

$$n^{r-2} \mathcal{O} \left(\frac{1}{n^\delta} \right)$$

where the constant in the error term depends on r and $\tilde{\mathbf{t}}$.

The second error term in (4.58) is

$$\sum_{\alpha \in \Sigma_r} \sum_{\vec{n} \rightsquigarrow [n\tilde{\mathbf{t}}]} \mathcal{O} \left(\frac{|\vec{\kappa}|^2 n_j^{1-\delta}}{n} \right) = n^{r-2} \mathcal{O} \left(\frac{|\vec{\kappa}|^2 \|\tilde{\mathbf{t}}\|_\infty^{r-1-\delta}}{n^\delta} \right), \quad (4.60)$$

where we have used (1.8) with $\kappa_j^2 \leq (r-1) \sum_{j=1}^{r-1} (k_j I_{l \in E_j})^2$.

The third error term is already of the form $n^{r-2} \mathcal{O}(n^{-\delta})$ where the constant depends on $\tilde{\mathbf{t}}$. Thus it remains to show that for each $\alpha \in \Sigma_r$,

$$\left| \sum_{\substack{\vec{n} \rightsquigarrow [n\tilde{\mathbf{t}}]: \\ \vec{n} \in \mathbb{N}^{2r-3}}} \prod_{j=1}^{2r-3} e^{-\frac{\kappa_j^2}{2d} \binom{n_j}{n}} - n^{r-2} \int_{R_{\tilde{\mathbf{t}}}(\alpha)} \prod_{j=1}^{2r-3} e^{-\frac{\kappa_j^2 s_j}{2d}} d\vec{s} \right| = \mathcal{O} \left(\frac{1}{n^\delta} \right), \quad (4.61)$$

where the constant depends on $\tilde{\mathbf{t}}$, r and $\vec{\kappa}$. We rewrite the left hand side as

$$n^{r-2} \left| \frac{1}{n^{r-2}} \sum_{\substack{\vec{n} \rightsquigarrow [n\tilde{\mathbf{t}}]: \\ \vec{n} \in \mathbb{N}^{2r-3}}} \prod_{j=1}^{2r-3} e^{-\frac{\kappa_j^2}{2d} \binom{n_j}{n}} - \int_{R_{\tilde{\mathbf{t}}}(\alpha)} \prod_{j=1}^{2r-3} e^{-\frac{\kappa_j(\alpha)^2 s_j}{2d}} d\vec{s} \right|. \quad (4.62)$$

Observe that the left hand term inside the absolute value is the Riemann sum approximation to the integral on the right, with the approximation breaking $R_{\vec{t}}(\alpha)$ into cubes of side $\frac{1}{n}$, and the error in the approximation arising from boundary cubes. The set $R_{\vec{t}}(\alpha)$ is a convex $r - 2$ dimensional subset of \mathbb{R}^{2r-3} . As such there are at most $C_1 n^{r-3}$ boundary cubes in the discrete approximation, each of volume $\frac{1}{n^{r-2}}$, where C_1 is a constant depending on \vec{t} and r . Since the integrand (and summand) is uniformly bounded by 1, the contribution to the left hand side of (4.62) from the boundary terms is $\mathcal{O}\left(\frac{1}{n}\right)$ where the constant depends on \vec{t} and r . Within each cube of side $\frac{1}{n}$ we have, for all \vec{s} in that cube,

$$\left| e^{-\frac{\kappa_j^2}{2d} \frac{n_j}{n}} - e^{-\frac{\kappa_j^2 s_j}{2d}} \right| \leq \frac{\kappa_j^2}{2d} \left| s_j - \frac{n_j}{n} \right| = \mathcal{O}\left(\frac{\kappa_j^2}{n}\right).$$

By a telescoping sum representation (as in (4.55)) we see that for all \vec{s} in that cube,

$$\prod_{j=1}^{2r-3} e^{-\frac{\kappa_j^2}{2d} \left(\frac{n_j}{n}\right)} - \prod_{j=1}^{2r-3} e^{-\frac{\kappa_j^2 s_j}{2d}} = \mathcal{O}\left(\frac{|\vec{\kappa}|^2}{n}\right).$$

Using $\kappa_j^2 \leq (r-1) \sum_{j=1}^{r-1} (k_j I_{l \in E_j})^2$, this verifies (4.61) and hence proves the Theorem. \square

5 Diagrams for the 2-point function

Proposition 3.6 was needed to advance the induction argument for the 2-point function in Section 3. In this section we estimate various diagrams arising from the lace expansion on an interval (star-shaped network of degree 1) and prove a more detailed result, Proposition 5.1. We first introduce some definitions and notation that will be used throughout this section, and prove various lemmas giving bounds on the building blocks of the diagrams for the r -point functions. In Section 5.1 we prove Proposition 5.1 assuming Lemmas 5.4, 5.6, and 5.7. Lemmas 5.6, 5.7 and 5.4 are then proved in subsequent sections. Throughout the remainder of this paper, unless otherwise specified, C denotes a constant that depends on d and K but not on L , m , z , or N . It may change from place to place without explicit comment.

Let $\pi_m(x; \zeta)$ be defined by (3.5), with U_{st} given by (3.1). Recall that $\pi_0(x; \zeta) = \rho(o)I_{x=0}$, and writing $U_{st} = (-1)(-U_{st})$ in (2.10) we have for $m \geq 1$,

$$\pi_m(x; \zeta) = \zeta^m \sum_{N=1}^{\infty} (-1)^N \sum_{L \in \mathcal{L}^N([0, m])} \sum_{\substack{\omega: o \rightarrow x \\ |\omega|=m}} W(\omega) \prod_{i=0}^m \sum_{R_i \in \mathcal{T}(\omega(i))} W(R_i) \prod_{st \in L} [-U_{st}] \prod_{s't' \in \mathcal{C}(L)} [1 + U_{s't'}]. \quad (5.1)$$

The sum over N is finite, since a lace on $[0, m]$ can contain at most m bonds. We define

$$\pi_m^N(x; \zeta) = \zeta^m \sum_{L \in \mathcal{L}^N([0, m])} \sum_{\substack{\omega: o \rightarrow x \\ |\omega|=m}} W(\omega) \prod_{i=0}^m \sum_{R_i \in \mathcal{T}(\omega(i))} W(R_i) \prod_{st \in L} [-U_{st}] \prod_{s't' \in \mathcal{C}(L)} [1 + U_{s't'}], \quad (5.2)$$

and from (5.1) we have for $m \geq 1$ that $\pi_m(x; \zeta) = \sum_{N=1}^{\infty} (-1)^N \pi_m^N(x; \zeta)$ and hence $|\pi_m(x; \zeta)| \leq \sum_N \pi_m^N(x; \zeta)$. Therefore, when β is sufficiently small, Proposition 3.6 follows immediately (by summing over N) from the following Proposition.

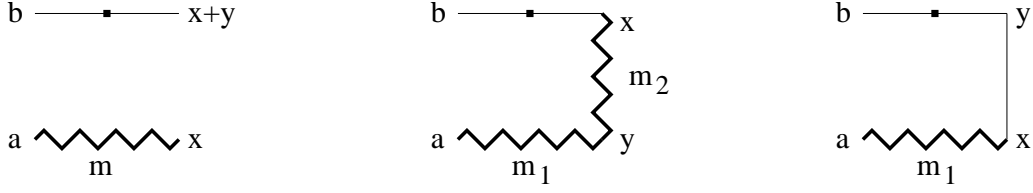

Figure 16: Feynman diagrams for $M_m^{(1)}(a, b, x, y)$, $A_{m_1, m_2}(a, b, x, y)$ and $A_{m_1, 0}(a, b, x, y)$. A jagged line between two vertices u and v represents a quantity $h_{m_i}(v - u)$. A straight line between two vertices u and v represents the quantity $\rho(v - u)$.

Proposition 5.1. *Suppose the bounds (3.24) hold for some $n \geq 1$, $z^* \in (0, 2)$, $K > 1$, $L \geq L_0$ and every $m \leq n$. Then for that K, L , and for all $z \in [0, z^*]$, $m \leq n + 1$ and $q \in \{0, 1, 2\}$,*

$$\sum_x |x|^{2q} \pi_m^N(x; \zeta) \leq \frac{\sigma^{2q} \left(C \beta^{2 - \frac{6\nu}{d}} \right)^N}{m^{\frac{d-4}{2} - q}}, \quad (5.3)$$

where $\zeta = z(\rho(o)p_c)^{-1}$, the constant $C = C(K, d)$ does not depend on L, m, z, N , and where $\nu > 0$ is the constant appearing in Theorem 1.9.

Define $h_m(u) = h_m(u; \zeta)$ by

$$h_m(u) = \begin{cases} \zeta^2 p_c^2 (D * t_{m-2} * D)(u), & \text{if } m \geq 2 \\ \zeta p_c D(u), & \text{if } m = 1 \\ I_{\{u=0\}}, & \text{if } m = 0, \end{cases} \quad (5.4)$$

where $t_0(u) = \rho(o)I_{\{u=0\}}$.

Definition 5.2. *For $q \in \{0, 1\}$, $m \in \mathbb{Z}_+$ we define $s_{m,q}(x) = |x|^{2q} h_m(x)$. For $l \geq 1$ we define $s_{\vec{m}^{(l)}, \vec{q}^{(l)}}^{(l)}(x)$ to be the l -fold spatial convolution of the s_{m_i, q_i} .*

Definition 5.3. *For $r \in \{0, 1\}$, let $\phi_r(x) = |x|^{2r} \rho(x)$. For $l \in \{1, 2, 3, 4\}$, let $\phi_{\vec{r}^{(l)}}^{(l)}(x)$ denote the l -fold spatial convolution of the ϕ_{r_i} (whenever this exists for all x), and define $\phi^{(0)}(x) = I_{\{x=0\}}$.*

Lemma 5.4. *Let $l \geq 1$, and $k \in \{0, 1, 2, 3, 4\}$. Let $\vec{m}^{(l)} \in \mathbb{Z}_+^l$ and $m = \sum_{i=1}^l m_i$. If the bounds (3.24) hold for $1 \leq m \leq n$ and $z \in [0, 2]$ then for all $m \leq n + 1$ and $z \in [0, 2]$, and for all $\vec{r} \in \{0, 1\}^k$ such $2(k + \sum_{i=1}^k r_i) \leq 8$,*

$$\|s_{\vec{m}^{(l)}, \vec{q}^{(l)}}^{(l)} * \phi_{\vec{r}^{(k)}}^{(k)}\|_\infty \leq m^{\sum q_i + \sum r_j} \sigma^{2(\sum q_i + \sum r_j)} \frac{C_l \beta^{2 - \frac{2k\nu}{d}}}{m^{\frac{d-2k}{2}}}, \quad \text{and} \quad \|s_{\vec{m}^{(l)}, \vec{q}^{(l)}}^{(l)}\|_1 \leq C_l m^{\sum q_i} \sigma^{2 \sum q_i}. \quad (5.5)$$

Definition 5.5. *Let*

$$M_m^{(1)}(a, b, x, y) \equiv h_m(x - a) \rho^{(2)}(x + y - b), \quad (5.6)$$

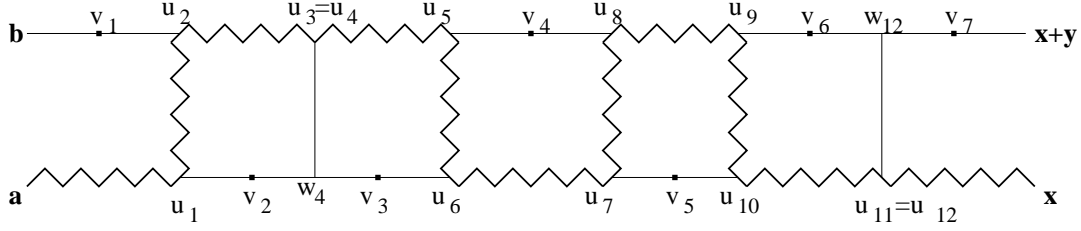

Figure 17: An example of an “opened” Feynman diagram, $M_{\vec{m}}^{(7)}(a, b, x, y)$ arising from the lace expansion. The jagged path from 0 to x represents the backbone.

and

$$A_{m_1, m_2}(a, b, x, y) \equiv \begin{cases} h_{m_1}(y-a)h_{m_2}(x-y)\rho^{(2)}(b-x), & m_2 \neq 0, \\ h_{m_1}(x-a)\rho(y-x)\rho^{(2)}(b-y), & m_2 = 0. \end{cases} \quad (5.7)$$

We recursively define

$$M_{\vec{m}}^{(N)}(a, b, x, y) \equiv \sum_{u, v} A_{m_1, m_2}(a, b, u, v) M_{(m_3, \dots, m_{2N-1})}^{(N-1)}(u, v, x, y). \quad (5.8)$$

The diagrammatic representation of these quantities appears in Figures 16 and 17.

Lemma 5.6. *Set $u_0 = a$ and $u_{2N-1} = x$. For every $N \geq 2$, and \vec{m} such that $m_i > 0$ for each odd i ,*

$$\begin{aligned} M_{\vec{m}}^{(N)}(a, b, x, y) &= \sum_{u_1} \cdots \sum_{u_{2N-2}} \left[\prod_{i=1}^{2N-1} h_{m_i}(u_i - u_{i-1}) \right] \sum_{v_1, \dots, v_N} \rho(v_1 - b)\rho(v_N - (x+y)) \times \\ &\quad \left[\prod_{l \geq 2: m_l = 0} \sum_{w_l} \rho(w_l - u_{l-1})\rho(v_{\frac{l+2}{2}} - w_l)\rho(v_{\frac{l}{2}} - w_l) \right] \times \\ &\quad \prod_{\substack{1 \leq l \leq 2N-2: \\ m_l, m_{l+1} \neq 0}} \left(\rho(v_{\frac{l}{2}} - u_l)I_{\{l \text{ even}\}} + \rho(v_{\frac{l+3}{2}} - u_l)I_{\{l \text{ odd}\}} \right) \\ &= \sum_{u, v} M_{(m_1, \dots, m_{2N-3})}^{(N-1)}(a, b, u, v) A_{m_{2N-1}, m_{2N-2}}(x, y, u, v). \end{aligned} \quad (5.9)$$

We also make use of the following notation. Let

$$\mathcal{H}_m^N = \left\{ \vec{m} \in \mathbb{Z}_+^{2N-1} : \sum_{i=1}^{2N-1} m_i = m, m_{2j} \geq 0, m_{2j-1} > 0 \right\}. \quad (5.10)$$

For general $N \geq 2$ we let

$$E_m^N = \left\{ \vec{m} \in \mathcal{H}_m^N : m_2 + m_1 \leq \frac{2m}{3} \right\}, \quad F_m^N = \left\{ \vec{m} \in \mathcal{H}_m^N : m_{2N-2} + m_{2N-1} \leq \frac{2m}{3} \right\}, \quad (5.11)$$

and for $N = 2$ we also define

$$G_m^2 = \{\vec{m} \in \mathcal{H}_m^2 : (m_1 \vee m_3) \leq m_2\}. \quad (5.12)$$

Note that for $N \geq 3$, $E_m^N \cup F_m^N = \mathcal{H}_m^N$ and for $N = 2$, $E_m^2 \cup F_m^2 \cup G_m^2 = \mathcal{H}_m^2$.

Lemma 5.7. For $q \in \{0, 1, 2\}$ and $N \geq 1$,

$$\sum_x |x|^{2q} \pi_m^N(x; \zeta) \leq \sum_{\vec{m} \in \mathcal{H}_m^N} \sum_x |x|^{2q} M_{\vec{m}}^{(N)}(0, 0, x, 0). \quad (5.13)$$

Observe that there are two disjoint paths in the diagram $M_{\vec{m}}^{(N)}(a, a, x, 0)$ from a to x (each having displacement $x - a$), corresponding to taking the uppermost path and the lowest path. In the opened diagram $M_{\vec{m}}^{(N)}(a, b, x, y)$, the corresponding uppermost path may be from b to x or from b to $x + y$ depending on \vec{m} . Similarly the right endpoint of the lowest path depends on \vec{m} . We define $\bar{z} = \bar{z}(\vec{m}, x, b, y)$ and $\underline{z} = \underline{z}(\vec{m}, x, a, y)$ by

$$\bar{z} = \begin{cases} x - b & \text{if } \#\{m_{2j} : m_{2j} \neq 0\} \text{ is odd} \\ x + y - b & \text{if } \#\{m_{2j} : m_{2j} \neq 0\} \text{ is even} \end{cases}, \quad \underline{z} = \begin{cases} x + y - a & \text{if } \#\{m_{2j} : m_{2j} \neq 0\} \text{ is odd} \\ x - a & \text{if } \#\{m_{2j} : m_{2j} \neq 0\} \text{ is even.} \end{cases} \quad (5.14)$$

5.1 Proof of Proposition 5.1

In this section we prove Proposition 5.1, assuming Lemmas 5.4 and 5.7. We prove the three cases $q = 0, 1, 2$ separately, by induction over N .

Case 1: $q = 0$. Our induction hypothesis is that

$$\sum_{\vec{m} \in \mathcal{H}_m^N} \sup_{a, b, y} \sum_x M_{\vec{m}}^{(N)}(a, b, x, y) \leq \frac{(C\beta^{2-\frac{6\nu}{d}})^N}{m^{\frac{d-4}{2}}}. \quad (5.15)$$

In view of Lemma 5.7 with $q = 0$, this clearly implies Proposition 5.1 with $q = 0$.

For $N = 1$ note that

$$\begin{aligned} \sup_{a, b, y} \sum_x M_m^{(1)}(a, b, x, y) &= \sup_{a, b, y} \sum_x h_m(x - a) \rho^{(2)}(x + y - b) \\ &= \sup_{a, b, y} \sum_x h_m(x) \rho^{(2)}(x + y - b + a) = \sup_z \sum_x h_m(x) \rho^{(2)}(x + z). \end{aligned} \quad (5.16)$$

Applying (5.5) with $l = 1$, $k = 2$ and all $q_i = r_j = 0$, this is bounded by $\frac{C\beta^{2-\frac{4\nu}{d}}}{m^{\frac{d-4}{2}}}$ as required.

For general N , we consider separately the contributions to (5.15) from E_m^N and F_m^N , and in the

case $N = 2$ also the contribution from G_m^2 . By (5.8) we have

$$\begin{aligned}
\sum_{\vec{m} \in E_m^N} \sup_{a,b,y} \sum_x M_{\vec{m}}^{(N)}(a,b,x,y) &= \sum_{m_1 \leq \frac{2m}{3}} \sum_{m_2 \leq \frac{2m}{3} - m_1} \sum_{\vec{m}' \in \mathcal{H}_{m-(m_1+m_2)}^{N-1}} \sup_{a,b} \sum_{u,v} A_{m_1,m_2}(a,b,u,v) \\
&\quad \times \sup_y \sum_x M_{\vec{m}'}^{(N-1)}(u,v,x,y) \\
&= \sum_{m_1 \leq \frac{2m}{3}} \sum_{m_2 \leq \frac{2m}{3} - m_1} \sup_{a,b} \sum_{u,v} A_{m_1,m_2}(a,b,u,v) \\
&\quad \times \sum_{\vec{m}' \in \mathcal{H}_{m-(m_1+m_2)}^{N-1}} \sup_{u',v',y} \sum_x M_{\vec{m}'}^{(N-1)}(u',v',x,y) \\
&\leq \sum_{m_1 \leq \frac{2m}{3}} \sum_{m_2 \leq \frac{2m}{3} - m_1} \sup_{a,b} \sum_{u,v} A_{m_1,m_2}(a,b,u,v) \frac{(C\beta^{2-\frac{6\nu}{d}})^{N-1}}{(m-(m_1+m_2))^{\frac{d-4}{2}}},
\end{aligned} \tag{5.17}$$

where we have applied the induction hypothesis in the last step. Since $m_1 + m_2 \leq \frac{2m}{3}$ in the range we are summing over, the last line of (5.17) is bounded by

$$3^{\frac{d-4}{2}} \frac{(C\beta^{2-\frac{6\nu}{d}})^{N-1}}{m^{\frac{d-4}{2}}} \sum_{m_1 \leq \frac{2m}{3}} \sum_{m_2 \leq \frac{2m}{3} - m_1} \sup_{a,b} \sum_{u,v} A_{m_1,m_2}(a,b,u,v). \tag{5.18}$$

Finally we split the sum over m_2 into the two cases $m_2 = 0$, $m_2 > 0$ to get

$$\begin{aligned}
\sum_{m_1 \leq \frac{2m}{3}} \sum_{m_2 \leq \frac{2m}{3} - m_1} \sup_{a,b} \sum_{u,v} A_{m_1,m_2}(a,b,u,v) &= \sum_{m_1 \leq \frac{2m}{3}} \sup_{a,b} \sum_{u,v} h_{m_1}(u-a)\rho(v-u)\rho^{(2)}(b-v) \\
&\quad + \sum_{m_1 \leq \frac{2m}{3}} \sum_{0 < m_2 \leq \frac{2m}{3} - m_1} \sup_{a,b} \sum_{u,v} h_{m_1}(v-a)h_{m_2}(u-v)\rho^{(2)}(b-u) \\
&\leq \sum_{m_1 \leq \frac{2m}{3}} \frac{C\beta^{2-\frac{6\nu}{d}}}{m_1^{\frac{d-6}{2}}} + \sum_{m_1 \leq \frac{2m}{3}} \sum_{0 < m_2 \leq \frac{2m}{3} - m_1} \frac{C\beta^{2-\frac{4\nu}{d}}}{[m_1+m_2]^{\frac{d-4}{2}}} \leq C\beta^{2-\frac{6\nu}{d}},
\end{aligned} \tag{5.19}$$

where we have applied (5.5) with all $q_i = r_j = 0$ in the penultimate step and the fact that $d > 8$ in the last step. Combining (5.17)–(5.19), we get the desired bound

$$\sum_{\vec{m} \in E_m^N} \sup_{a,b,y} \sum_x M_{\vec{m}}^{(N)}(a,b,x,y) \leq \frac{(C\beta^{2-\frac{6\nu}{d}})^N}{m^{\frac{d-4}{2}}}. \tag{5.20}$$

Similarly using the symmetry of $M_{\vec{m}}^{(N)}$ (in the form of the second equality of (5.9)) and writing n_1 for m_{2N-1} and n_2 for m_{2N-2} we get

$$\begin{aligned}
\sum_{\vec{m} \in F_m^N} \sup_{a,b,y} \sum_x M_{\vec{m}}^{(N)}(a,b,x,y) &= \sum_{n_1 \leq \frac{2m}{3}} \sum_{n_2 \leq \frac{2m}{3} - n_1} \sum_{\vec{m}' \in \mathcal{H}_{m-n_1-n_2}^{N-1}} \sup_{u',y} \sum_{x,v} A_{n_1,n_2}(x,y,u',v) \times \\
&\quad \sup_{a,b,v'} \sum_u M_{\vec{m}'}^{(N-1)}(a,b,u,v').
\end{aligned} \tag{5.21}$$

Using translation invariance of $A_{n_1, n_2}(x, y, u', v)$ we proceed as in (5.17)–(5.19) to get

$$\sum_{\vec{m} \in F_m^N} \sup_{a, b, y} \sum_x M_{\vec{m}}^{(N)}(a, b, x, y) \leq \frac{(C\beta^{2-\frac{6\nu}{d}})^N}{m^{\frac{d-4}{2}}},$$

as required.

It remains to prove the bound (5.15) for the sum over $\vec{m} \in G_m^2$. Note that in this case $m_2 \neq 0$ and so $M_{\vec{m}}^{(2)}(a, b, x, y)$ is equal to

$$\sum_{u, v} \rho^{(2)}(b-v) h_{m_1}(u-a) h_{m_-(m_1+m_3)}(v-u) h_{m_3}(x-v) \rho^{(2)}(x+y-u). \quad (5.22)$$

We break the sum over $\vec{m} \in G_m^2$ according to which of m_1 and m_3 is larger and note that $m_2 = m - (m_1 + m_3)$. By symmetry of $M_{\vec{m}}^{(2)}(a, b, x, y)$ and translation invariance we have

$$\begin{aligned} \sum_{\vec{m} \in G_m^2} \sup_{a, b, y} \sum_x M_{\vec{m}}^{(2)}(a, b, x, y) &\leq 2 \sum_{m_3 < \frac{m}{2}} \sum_{\substack{m_1 \leq m_3: \\ m-m_1 \geq m_3}} \sup_{a, b, y} \sum_x M_{\vec{m}}^{(2)}(a, b, x, y) \\ &\leq 2 \sum_{m_3 < \frac{m}{2}} \sum_{\substack{m_1 \leq m_3: \\ m-m_1 \geq m_3}} \sup_{b, y} \sum_{u, v} \rho^{(2)}(b-v) h_{m_1}(u) h_{m_-(m_1+m_3)}(v-u) \times \\ &\quad \sup_{u', v'} \sum_x h_{m_3}(x-v') \rho^{(2)}(x+y-u'), \end{aligned} \quad (5.23)$$

where in the last step we have subtracted a from each vertex and correspondingly changed variables (i.e. we have used translation invariance). This is bounded by

$$2 \sum_{m_3 < \frac{m}{2}} \sum_{\substack{m_1 \leq m_3: \\ m-m_1 \geq m_3}} \left(\sup_b \sum_{u, v} \rho^{(2)}(b-v) h_{m_1}(u) h_{m_-(m_1+m_3)}(v-u) \right) \left(\sup_{y, u', v'} \sum_x h_{m_3}(x-v') \rho^{(2)}(x+y-u') \right). \quad (5.24)$$

Applying (5.5) to both terms in the brackets, (5.24) is bounded by

$$\sum_{m_3 < \frac{m}{2}} \sum_{\substack{m_1 \leq m_3: \\ m-m_1 \geq m_3}} \frac{C\beta^{2-\frac{4\nu}{d}}}{(m-m_3)^{\frac{d-4}{2}}} \frac{C\beta^{2-\frac{4\nu}{d}}}{m_3^{\frac{d-4}{2}}} \leq \frac{(C\beta^{2-\frac{4\nu}{d}})^2}{m^{\frac{d-4}{2}}} \sum_{m_3 < \frac{m}{2}} \sum_{m_1 \leq m_3} \frac{1}{m_3^{\frac{d-4}{2}}} \leq \frac{(C\beta^{2-\frac{4\nu}{d}})^2}{m^{\frac{d-4}{2}}} \sum_{m_3 < \frac{m}{2}} \frac{1}{m_3^{\frac{d-6}{2}}}, \quad (5.25)$$

and we have the desired bound since $d > 8$. This completes the proof of Proposition 5.1 for $q = 0$. \square

Case 2: $q = 1$. Our induction hypotheses are that

$$\begin{aligned} \sum_{\vec{m} \in \mathcal{H}_m^N} \sup_{a, b, y} \sum_x |\bar{z}|^2 M_{\vec{m}}^{(N)}(a, b, x, y) &\leq \frac{\sigma^2 (C\beta^{2-\frac{6\nu}{d}})^N}{m^{\frac{d-6}{2}}}, \quad \text{and} \\ \sum_{\vec{m} \in \mathcal{H}_m^N} \sup_{a, b, y} \sum_x |z|^2 M_{\vec{m}}^{(N)}(a, b, x, y) &\leq \frac{\sigma^2 (C\beta^{2-\frac{6\nu}{d}})^N}{m^{\frac{d-6}{2}}}. \end{aligned} \quad (5.26)$$

In view of Lemma 5.7 with $q = 1$, these clearly imply Proposition 5.1 with $q = 1$.

For $N = 1$, the first statement of (5.26) is

$$\sup_{a,b,y} \sum_x |x+y-b|^2 h_m(x-a) \rho^{(2)}(x+y-b) \leq \frac{\sigma^2 (C\beta^{2-\frac{6\nu}{d}})^N}{m^{\frac{d-6}{2}}}. \quad (5.27)$$

Writing $\rho^{(2)}(x+y-b) = \sum_u \rho(u-b) \rho(x+y-u)$ and using $|x+y-b|^2 \leq 2(|u-b|^2 + |x+y-u|^2)$, (5.27) is bounded by

$$2 \sup_{a,b,y} \sum_x \phi_1(u-b) \rho(x+y-u) h_m(x-a) + 2 \sup_{a,b,y} \sum_x \rho(u-b) \phi_1(x+y-u) h_m(x-a). \quad (5.28)$$

Applying (5.5) to each term with $l = 1$, $k = 2$, $q_1 = 0$ and exactly one $r_j = 1$, (5.28) is bounded by $\sigma^2 (C\beta^{2-\frac{4\nu}{d}})^N m^{-\frac{d-6}{2}}$ as required. The second statement for $N = 1$ is

$$\sup_{a,b,y} \sum_x |x-a|^2 h_m(x-a) \rho^{(2)}(x+y-b) \leq \frac{\sigma^2 (C\beta^{2-\frac{6\nu}{d}})^N}{m^{\frac{d-6}{2}}}, \quad (5.29)$$

which follows immediately by applying (5.5) with $l = 1$, $k = 2$, $q_1 = 1$ and all $r_j = 0$.

For the inductive step, for each statement of (5.26) we break up the sum over $\vec{m} \in \mathcal{H}_m^N$ into sums over $\vec{m} \in E_m^N$, $\vec{m} \in F_m^N$, and when $N = 2$, also $\vec{m} \in G_m^2$. For the contribution from $\vec{m} \in E_m^N$ we write $|\vec{z}|^2 \leq 2(|\vec{z}_A|^2 + |z_M|^2)$ where

$$(z_M, \vec{z}_A) = \begin{cases} (x-u, u-b) & , \text{ if } \#\{m_{2j} : m_{2j} \neq 0\} \text{ is odd and } m_2 > 0 \\ (x+y-u, u-b) & , \text{ if } \#\{m_{2j} : m_{2j} \neq 0\} \text{ is even and } m_2 > 0 \\ (x-v, v-b) & , \text{ if } \#\{m_{2j} : m_{2j} \neq 0\} \text{ is odd and } m_2 = 0 \\ (x+y-v, v-b) & , \text{ if } \#\{m_{2j} : m_{2j} \neq 0\} \text{ is even and } m_2 = 0. \end{cases} \quad (5.30)$$

Thus

$$\begin{aligned} \sum_{\vec{m} \in E_m^N} \sup_{a,b,y} \sum_x |\vec{z}|^2 M_{\vec{m}}^{(N)}(a,b,x,y) &\leq 2 \sum_{\vec{m} \in E_m^N} \sup_{a,b,y} \sum_{x,u,v} |\vec{z}_A|^2 A_{m_1,m_2}(a,b,u,v) M_{\vec{m}'}^{(N-1)}(u,v,x,y) \\ &+ 2 \sum_{\vec{m} \in E_m^N} \sup_{a,b,y} \sum_{x,u,v} A_{m_1,m_2}(a,b,u,v) |z_M|^2 M_{\vec{m}'}^{(N-1)}(u,v,x,y). \end{aligned} \quad (5.31)$$

As in (5.17) the first term on the right of (5.31) is equal to

$$\begin{aligned} &2 \sum_{m_1 \leq \frac{2m}{3}} \sum_{m_2 \leq \frac{2m}{3} - m_1} \sup_{a,b} \sum_{u,v} |\vec{z}_A|^2 A_{m_1,m_2}(a,b,u,v) \frac{(C\beta^{2-\frac{6\nu}{d}})^{N-1}}{(m - (m_1 + m_2))^{\frac{d-4}{2}}} \\ &\leq C \frac{(C\beta^{2-\frac{6\nu}{d}})^{N-1}}{m^{\frac{d-4}{2}}} \sum_{m_1 \leq \frac{2m}{3}} \sum_{m_2 \leq \frac{2m}{3} - m_1} \sup_{a,b} \sum_{u,v} |\vec{z}_A|^2 A_{m_1,m_2}(a,b,u,v). \end{aligned} \quad (5.32)$$

We now proceed exactly as in (5.18)–(5.20) except that we use (5.5) with exactly one $r_j = 1$ (instead of all $r_j = 0$ as we did in (5.19)). This yields an upper bound on (5.32) of $\sigma^2 m (C\beta^{2-\frac{6\nu}{d}})^N m^{-\frac{d-4}{2}}$.

For the second term on the right of (5.31) note that by definition, z_M is either \bar{z}' or \underline{z}' , the displacement of the upper or lower path of $M^{(N-1)}(u, v, x, y)$. We proceed exactly as in (5.17)–(5.19) except that the induction hypotheses give a bound

$$\begin{aligned} \sum_{\vec{m}' \in \mathcal{H}_{m-(m_1+m_2), N-1}} \sup_{u', v', y} \sum_x |z_M|^2 M_{\vec{m}'}^{(N-1)}(u', v', x, y) &\leq \sigma^2 \frac{(C\beta^{2-\frac{6\nu}{d}})^{N-1}}{(m - (m_1 + m_2))^{\frac{d-6}{2}}} \\ &\leq \sigma^2 m \frac{(C\beta^{2-\frac{6\nu}{d}})^{N-1}}{(m - (m_1 + m_2))^{\frac{d-4}{2}}}, \end{aligned} \quad (5.33)$$

which contains an extra factor of $\sigma^2 m$ compared to that appearing in (5.17). We now proceed exactly as in (5.18)–(5.20) to get a bound on the second term on the right hand side of (5.31) of $\sigma^2 m (C\beta^{2-\frac{6\nu}{d}})^N m^{-\frac{d-4}{2}}$. This verifies the induction step for the first bound of the induction hypothesis (5.26).

As in the $q = 0$ case of Proposition 5.1, the bound

$$\sum_{\vec{m} \in F_m^N} \sup_{a, b, y} \sum_x |\bar{z}|^2 M_{\vec{m}}^{(N)}(a, b, x, y) \leq \frac{\sigma^2 (C\beta^{2-\frac{6\nu}{d}})^N}{m^{\frac{d-6}{2}}}, \quad (5.34)$$

follows by symmetry.

When $N = 2$, the contribution to (5.26) from $\vec{m} \in G_m^2$ is easily bounded as in (5.23) by applying (5.5) with exactly one of the q_i or $r_j = 0$. This gives the desired bound of $\sigma^2 (C\beta^{2-\frac{4\nu}{d}})^2 m^{-\frac{d-6}{2}}$ as required. By induction, the proof of Proposition 5.1 for $q = 1$ is complete. \square

Case 3: $q = 2$. Our induction hypothesis is that

$$\sum_{\vec{m} \in \mathcal{H}_m^N} \sup_{a, b, y} \sum_x |\bar{z}|^2 |\underline{z}|^2 M_{\vec{m}}^{(N)}(a, b, x, y) \leq \frac{\sigma^4 (C\beta^{2-\frac{6\nu}{d}})^N}{m^{\frac{d-8}{2}}}. \quad (5.35)$$

In view of Proposition 5.7 with $q = 2$, this clearly implies Proposition 5.1 with $q = 2$. The proof of (5.35) is very similar to the proof of (5.26) so we just present the main ideas.

The $N = 1$ case follows from (5.5) with $l = 1$, $k = 2$, $q_1 = 1$ and exactly one $r_i = 1$. To bound

$$\sum_{\vec{m} \in E_m^N} \sup_{a, b, y} \sum_x |\bar{z}|^2 |\underline{z}|^2 M_{\vec{m}}^{(N)}(a, b, x, y), \quad (5.36)$$

we use the expansions $|\bar{z}|^2 \leq 2(|\cdot|^2 + |\cdot|^2)$ and $|\underline{z}|^2 \leq 2(|\cdot|^2 + |\cdot|^2)$ yielding 4 terms instead of the two in (5.31). One such term is

$$4 \sum_{\vec{m} \in E_m^N} \sup_{a, b, y} \sum_{x, u, v} |\bar{z}_A|^2 |\underline{z}_A|^2 A_{m_1, m_2}(a, b, u, v) M_{\vec{m}}^{(N-1)}(u, v, x, y), \quad (5.37)$$

on which we use the $q = 0$ case of Proposition 5.1, and (5.5) with $q_1 = 1$ and exactly one of the $r_j = 1$. For two of the remaining three terms arising from (5.36) we use the $q = 1$ case of

Proposition 5.1 and (5.5) with exactly one of $q_1 = 1$ or some $r_j = 1$. The remaining term arising from (5.36) is

$$4 \sum_{\vec{m} \in E_m^N} \sup_{a,b,y} \sum_{x,u,v} A_{m_1,m_2}(a,b,u,v) |\bar{z}'|^2 |\underline{z}'|^2 M_{\vec{m}'}^{(N-1)}(u,v,x,y), \quad (5.38)$$

which we bound using the induction hypothesis and (5.5) with all $q_i, r_j = 0$. Collecting the 4 terms we obtain the bound

$$\sum_{\vec{m} \in E_m^N} \sup_{a,b,y} \sum_x |\bar{z}|^2 |\underline{z}|^2 M_{\vec{m}}^{(N)}(a,b,x,y) \leq \frac{\sigma^4 (C\beta^{2-\frac{4\nu}{d}})^2}{m^{\frac{d-8}{2}}}. \quad (5.39)$$

The contribution from $\vec{m} \in F_m^N$ also obeys the bound (5.39) by symmetry, while the contribution from $\vec{m} \in G_m^2$ when $N = 2$ is handled as for the $q = 1$ case of Proposition 5.1 except that we have exactly two of the q_i, r_j equal to 1 when we apply (5.5). This completes the proof of Proposition 5.1 for $q = 2$, and hence completes the proof of Proposition 5.1. \square

5.2 Proof of Lemma 5.6

For the first equality of (5.9), we prove the result by induction on N and leave the reader to verify the easiest case, $N = 2$ (consider the two cases $m_2 > 0, m_2 = 0$).

For $N \geq 3$, if $m_2 > 0$ then by inserting (5.9) for $N - 1$ into (see (5.8)),

$$M_{\vec{m}}^{(N)}(a,b,x,y) = \sum_{u_2,u_1} A_{m_1,m_2}(a,b,u_2,u_1) M_{(m_3,\dots,m_{2N-1})}^{(N-1)}(u_2,u_1,x,y)$$

we see that $M_{\vec{m}}^{(N)}(a,b,x,y)$ is equal to

$$\begin{aligned} & \sum_{u_1,u_2} \left(h_{m_1}(u_1 - a) h_{m_2}(u_2 - u_1) \sum_{v_1} \rho(v_1 - b) \rho(v_{\frac{v_2}{2}} - u_2) \right) \left(\sum_{u_3} \cdots \sum_{u_{2N-2}} \left[\prod_{i=3}^{2N-1} h_{m_i}(u_i - u_{i-1}) \right] \right) \times \\ & \sum_{v_2,\dots,v_N} \rho(v_{\frac{v_1+3}{2}} - u_1) \rho(v_N - (x + y)) \left[\prod_{l \geq 4: m_l = 0} \sum_{w_l} \rho(w_l - u_{l-1}) \rho(v_{\frac{l+2}{2}} - w_l) \rho(v_{\frac{l}{2}} - w_l) \right] \times \\ & \prod_{\substack{3 \leq l \leq 2N-2: \\ m_l, m_{l+1} \neq 0}} \left(\rho(v_{\frac{l}{2}} - u_l) I_{\{l \text{ even}\}} + \rho(v_{\frac{l+3}{2}} - u_l) I_{\{l \text{ odd}\}} \right). \end{aligned} \quad (5.40)$$

Reordering the sums and using the fact that $m_2 > 0$, this is precisely the right hand side of the first equality of (5.9) in the case $m_2 > 0$.

If $m_2 = 0$ then by inserting (5.9) for $N - 1$ into,

$$M_{\vec{m}}^{(N)}(a,b,x,y) = \sum_{u_1,w_2} A_{m_1,m_2}(a,b,u_1,w_2) M_{(m_3,\dots,m_{2N-1})}^{(N-1)}(u_1,w_2,x,y)$$

we have that $M_{\vec{m}}^{(N)}(a, b, x, y)$ is equal to

$$\begin{aligned} & \sum_{u_1, w_2} \sum_{u_2} \left(h_{m_1}(u_1 - a) h_0(u_2 - u_1) \sum_{v_1} \rho(v_1 - b) \rho(w_2 - u_1) \rho(v_{\frac{2}{2}} - w_2) \right) \times \\ & \left(\sum_{u_3} \cdots \sum_{u_{2N-2}} \left[\prod_{i=3}^{2N-1} h_{m_i}(u_i - u_{i-1}) \right] \times \sum_{v_2, \dots, v_N} \rho(v_{\frac{2+2}{2}} - w_2) \rho(v_N - (x + y)) \right. \\ & \left. \left[\prod_{l \geq 4: m_l = 0} \sum_{w_l} \rho(w_l - u_{l-1}) \rho(v_{\frac{l+2}{2}} - w_l) \rho(v_{\frac{l}{2}} - w_l) \right] \times \prod_{\substack{3 \leq l \leq 2N-2: \\ m_l, m_{l+1} \neq 0}} \left(\rho(v_{\frac{l}{2}} - u_l) I_{\{l \text{ even}\}} + \rho(v_{\frac{l+3}{2}} - u_l) I_{\{l \text{ odd}\}} \right) \right). \end{aligned} \quad (5.41)$$

Reordering the sums and using the fact that $m_2 = 0$, this is precisely the right hand side of the first equality of (5.9) in the case $m_2 = 0$. The second equality is the same by symmetry of the expression for $M_{\vec{m}}^{(N)}$ in the first equality, by considering the cases $m_{2N-2} > 0$ and $m_{2N-2} = 0$ and separating the terms $l = 2N - 1, 2N - 2$. \square

5.3 Proof of Proposition 5.7

We prove the stronger result that

$$\pi_m^N(x; \zeta) \leq \sum_{\vec{m} \in \mathcal{H}_m^N} M_{\vec{m}}^{(N)}(0, 0, x, 0). \quad (5.42)$$

Recall the definition of $\pi_m^N(x; \zeta)$ from (5.2).

For $N = 1$ there is only one lace $L = \{0m\}$ on $[0, m]$ and every other bond is compatible with $\{0m\}$, so by (5.2)

$$\begin{aligned} \pi_m^1(x; \zeta) &= \zeta^m \sum_{\substack{\omega: 0 \rightarrow x \\ |\omega|=m}} W(\omega) \prod_{i=0}^m \sum_{R_i \in \mathcal{T}(\omega(i))} W(R_i) [-U_{0m}] \prod_{b \neq 0m} [1 + U_b] \\ &= \sum_{R_0 \in \mathcal{T}(0)} W(R_0) \sum_{R_m \in \mathcal{T}(x)} W(R_m) [-U_{0m}] \left(\zeta^m \sum_{\substack{\omega: 0 \rightarrow x \\ |\omega|=m}} W(\omega) \prod_{i=1}^{m-1} \sum_{R_i \in \mathcal{T}(\omega(i))} W(R_i) \prod_{b \neq 0m} [1 + U_b] \right). \end{aligned} \quad (5.43)$$

Note that everything in this expression is non-negative. Now $-U_{0m} = I_{\{R_0 \cap R_m \neq \emptyset\}}$ so $\pi_m^1(x; \zeta)$ is nonzero if and only if there exists $v \in \mathbb{Z}^d$ such that $v \in R_0 \cap R_m$ and therefore

$$\sum_{R_0 \in \mathcal{T}(0)} W(R_0) \sum_{R_m \in \mathcal{T}(x)} W(R_m) [-U_{0m}] \leq \sum_v \sum_{R_0 \in \mathcal{T}(0, v)} W(R_0) \sum_{R_m \in \mathcal{T}(x, v)} W(R_m) = \sum_v \rho(v) \rho(v - x). \quad (5.44)$$

If $m = 1$ then the term in brackets in the last line of (5.43) is $\zeta p_c D(x)$ as required. For $m \geq 2$, $\prod_{b \neq 0m} [1 + U_b] \leq \prod_{1 \leq s < t \leq m-1} [1 + U_{st}]$ and letting y_1 (resp. y_2) be the location of the walk ω

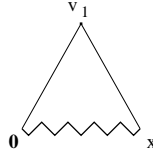

Figure 18: The Feynman diagram corresponding to the lace containing one bond. The jagged line represents the quantity $h_m(x)$, while straight line between 0 (resp. x) and v_1 represents the quantity $\rho(v_1)$ (resp. $\rho(x - v_1)$).

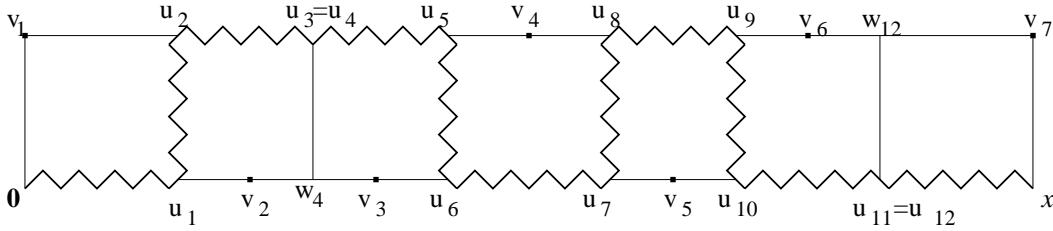

Figure 19: An example of the Feynman diagrams arising from the lace expansion. A jagged lines from u_{i-1} to u_i represents the quantity $h_{m_i}(u_i - u_{i-1})$ (derived from the backbone from 0 to x). A straight line between two vertices u and v represents the quantity $\rho(v - u)$ (derived from intersections of branches emanating from the backbone).

after 1 step (resp. $m - 1$ steps) we have

$$\begin{aligned}
 \zeta^m \sum_{\substack{\omega: 0 \rightarrow x \\ |\omega|=m}} W(\omega) \prod_{i=1}^{m-1} \sum_{R_i \in \mathcal{T}(\omega(i))} W(R_i) \prod_{b \neq 0m} [1 + U_b] &\leq \sum_{y_1} \sum_{y_2} \zeta^{p_c D}(y_1) \zeta^{p_c D}(x - y_2) \times \\
 &\zeta^{m-2} \sum_{\substack{\omega': y_1 \rightarrow y_2 \\ |\omega'|=m-2}} W(\omega') \prod_{j=0}^{m-2} \sum_{R_j \in \mathcal{T}(\omega'(j))} W(R_j) \prod_b [1 + U_b] \\
 &= h_m(x).
 \end{aligned} \tag{5.45}$$

Combining (5.43)–(5.45) gives the desired result for $N = 1$. See Figure 18 for the diagrammatic representation of this bound.

For $N \geq 2$ the reader should refer to Figure 19 to help understand the following derivation. Firstly $L \in \mathcal{L}^N([0, m])$ if and only if $L = \{s_1 t_1, \dots, s_N t_N\}$ where $s_1 = 0, t_N = m$ and for each i , $s_i < s_{i+1} \leq t_i < s_{i+2}$. Hence from (5.2), $\pi_m^N(x; \zeta)$ is equal to

$$\zeta^m \sum_{\substack{\{s_1 t_1, \dots, s_N t_N\} \\ \in \mathcal{L}^N([0, m])}} \sum_{\substack{\omega: 0 \rightarrow x \\ |\omega|=m}} W(\omega) \prod_{i=0}^m \sum_{R_i \in \mathcal{T}(\omega(i))} W(R_i) \prod_{i=1}^N [-U_{s_i t_i}] \prod_{b \in \mathcal{C}(L)} [1 + U_b]. \tag{5.46}$$

Everything in this expression is nonnegative, and every bond $b = st$ such that $s_1 < s < t < s_2$, or $t_{N-1} < s < t < t_N$, or $s_{i+1} < s < t < t_i$, or $t_i < s < t < s_{i+2}$, is compatible with

$L = \{s_1 t_1, \dots, s_N t_N\}$. Therefore (5.46) is bounded above by

$$\begin{aligned} \zeta^m & \sum_{\substack{\{s_1 t_1, \dots, s_N t_N\} \\ \in \mathcal{L}^N([0, m])}} \sum_{\substack{\omega: o \rightarrow x \\ |\omega|=m}} W(\omega) \prod_{i=0}^m \sum_{R_i \in \mathcal{T}(\omega(i))} W(R_i) \prod_{i=1}^N [-U_{s_i t_i}] \times \\ & \prod_{b \in (s_1, s_2)} [1 + U_b] \prod_{b \in (t_{N-1}, t_N)} [1 + U_b] \prod_{i=1}^{N-1} \prod_{b \in (s_{i+1}, t_i)} [1 + U_b] \prod_{j=1}^{N-2} \prod_{b \in (t_j, s_{j+2})} [1 + U_b], \end{aligned} \quad (5.47)$$

where for $b = st$ we are using the notation $b \in (a, b)$ to mean $a < s < t < b$.

For $L = \{s_1 t_1, \dots, s_N t_N\} \in \mathcal{L}^N([0, m])$ we define $\vec{m}(L) \in \mathbb{Z}_+^{2N-1}$ by

$$m_1 = s_2 - 0, \quad m_{2N-1} = m - t_{N-1}, \quad m_{2i} = t_i - s_{i+1}, \quad m_{2i-1} = s_{i+1} - t_{i-1}. \quad (5.48)$$

Then $m_{2i} \geq 0$, $m_{2i-1} > 0$ and $\sum_{i=1}^{2N-1} m_i = m$, so $\vec{m} \in \mathcal{H}_m^N$. Similarly for any $\vec{m} \in \mathcal{H}_m^N$ we define $L(\vec{m}) = \{s_1 t_1, \dots, s_N t_N\} \in \mathcal{G}([0, m])$ by

$$s_1 = 0, \quad t_N = m, \quad t_i = \sum_{j=1}^{2i} m_j, \quad i = 1, \dots, N-1, \quad s_l = \sum_{j=1}^{2l-1} m_j, \quad l = 2, \dots, N. \quad (5.49)$$

Then for each i , $s_i < s_{i+1} \leq t_i < s_{i+2}$ so that $L(\vec{m}) \in \mathcal{L}^N([0, m])$. Thus (5.48)–(5.49) defines a bijection between $\mathcal{L}^N([0, m])$ and \mathcal{H}_m^N .

We break up the sum over walks ω in (5.47) according to the subintervals defined by $\{s_1 t_1, \dots, s_N t_N\}$ and obtain

$$\begin{aligned} \sum_{\substack{\omega: o \rightarrow x \\ |\omega|=m}} W(\omega) &= \sum_{u_1, \dots, u_{2N-1}} \sum_{\substack{\omega_1: o \rightarrow u_1 \\ |\omega_1|=s_2-s_1}} W(\omega_1) \sum_{\substack{\omega_{2N-1}: u_{2N-2} \rightarrow x \\ |\omega_{2N-1}|=s_2-s_1}} W(\omega_{2N-1}) \times \\ & \prod_{i=1}^{N-1} \sum_{\substack{\omega_{2i}: u_{2i-1} \rightarrow u_{2i} \\ |\omega_{2i}|=t_i-s_{i+1}}} W(\omega_{2i}) \prod_{j=1}^{N-2} \sum_{\substack{\omega_{2j+1}: u_{2j} \rightarrow u_{2j+1} \\ |\omega_{2j+1}|=s_{j+2}-t_j}} W(\omega_{2j+1}). \end{aligned} \quad (5.50)$$

Then under this scheme, $\prod_{i=0}^m \sum_{R_i \in \mathcal{T}(\omega(i))} W(R_i)$ becomes

$$\sum_{R_0 \in \mathcal{T}(o)} W(R_0) \prod_{\substack{1 \leq i \leq 2N-1 \\ m_i \neq 0}} \left(\sum_{R_{i, m_i} \in \mathcal{T}(\omega_i(m_i))} W(R_{i, m_i}) \prod_{j=1}^{m_i-1} \sum_{R_{i, j} \in \mathcal{T}(\omega_i(j))} W(R_{i, j}) \right), \quad (5.51)$$

where $\omega_i(m_i) = u_i$, $(\omega_{2N-1}(m_{2N-1}) = x)$ and the product over i ensures that if some $s_l = t_{l-1}$ then we do not count the tree emanating from this vertex twice. Similarly the term $\prod_{i=1}^N [-U_{s_i t_i}] = \prod_{i=1}^N I_{\{R_{s_i} \cap R_{t_i} \neq \emptyset\}}$ becomes

$$\begin{aligned} & \left(I_{\{m_i \neq 0\}} + I_{\{m_i = 0\}} I_{\{R_{i, m_i} = R_{i-1, m_{i-1}}\}} \right) \times \\ & I_{\{R_0 \cap R_{2, m_2} \neq \emptyset\}} I_{\{R_{2N-3, m_{2N-3}} \cap R_{2N-1, m_{2N-1}} \neq \emptyset\}} \prod_{l=1}^{N-2} I_{\{R_{2l-1, m_{2l-1}} \cap R_{2l+2, m_{2l+2}} \neq \emptyset\}}. \end{aligned} \quad (5.52)$$

Note that (5.52) contains no information about $R_{i,j}$ for $0 < j < m_i$. Lastly we have that the second line of (5.47) becomes

$$\prod_{i=1}^{2N-1} \left(\prod_{1 \leq s < t \leq m_i-1} I_{\{R_{i,s} \cap R_{i,t} = \emptyset\}} \right). \quad (5.53)$$

Combining (5.47) with (5.50)–(5.53), and writing $u_0 = 0, u_{2N-1} = x$ we have that (5.47) is equal to

$$\begin{aligned} & \sum_{\vec{u}} \sum_{\vec{m} \in \mathcal{H}_m^N} \sum_{R_0 \in \mathcal{T}(o)} W(R_0) \prod_{\substack{1 \leq i \leq 2N-1: \\ m_i \neq 0}} \left(\sum_{R_{i,m_i} \in \mathcal{T}(u_i)} W(R_{i,m_i}) \right) \left(I_{\{m_i \neq 0\}} + I_{\{m_i = 0\}} I_{\{R_{i,m_i} = R_{i-1,m_{i-1}}\}} \right) \times \\ & I_{\{R_0 \cap R_{2,m_2} \neq \emptyset\}} I_{\{R_{2N-3,m_{2N-3}} \cap R_{2N-1,m_{2N-1}} \neq \emptyset\}} \prod_{l=1}^{N-2} I_{\{R_{2l-1,m_{2l-1}} \cap R_{2l+2,m_{2l+2}} \neq \emptyset\}} \times \\ & \prod_{i=1}^{2N-1} \left(\zeta^{m_i} \sum_{\substack{\omega_i: u_{i-1} \rightarrow u_i \\ |\omega_i| = m_i}} W(\omega_i) \prod_{j=1}^{m_i-1} \sum_{R_{i,j} \in \mathcal{T}(\omega_i(j))} W(R_{i,j}) \left(\prod_{1 \leq s < t \leq m_i-1} I_{\{R_{i,s} \cap R_{i,t} = \emptyset\}} \right) \right). \end{aligned} \quad (5.54)$$

The last line of (5.54) is $\prod_{i=1}^{2N-1} h_{m_i}(u_i - u_{i-1})$ by definition.

For any collection of trees $\{R_{i,m_i} : 1 \leq i \leq 2N-1\}$ for which (5.52) is nonzero we choose $v_i \in \mathbb{Z}^d$, $i = 1, \dots, N$ as follows.

- (a) $I_{\{R_0 \cap R_{2,m_2} \neq \emptyset\}} = 1$ if and only if there exists a $v_1 \in \mathbb{Z}^d$ such that $v_1 \in R_0 \cap R_{2,m_2}$. This means that $R_0 \in \mathcal{T}(o, v_1)$ and $R_{2,m_2} \in \mathcal{T}(u_2, v_1)$.
- (b) Similarly $I_{\{R_{2N-3,m_{2N-3}} \cap R_{2N-1,m_{2N-1}} \neq \emptyset\}} = 1$ if and only if there exists a $v_N \in \mathbb{Z}^d$ such that $v_N \in R_{2N-3,m_{2N-3}} \cap R_{2N-1,m_{2N-1}}$. This means that $R_{2N-3,m_{2N-3}} \in \mathcal{T}(u_{2N-2}, v_N)$ and $R_{2N-1,m_{2N-1}} \in \mathcal{T}(x, v_N)$.
- (c) For each $i \in \{3, \dots, 2N-5\}$ such that i is odd, $I_{\{R_{i,m_i} \cap R_{i+3,m_{i+3}} \neq \emptyset\}} = 1$ if and only if there exists $v_{\frac{i+3}{2}} \in \mathbb{Z}^d$ such that $v_{\frac{i+3}{2}} \in R_{i,m_i} \cap R_{i+3,m_{i+3}}$. This means that $R_{i,m_i} \in \mathcal{T}(u_i, v_{\frac{i+3}{2}})$ and $R_{i+3,m_{i+3}} \in \mathcal{T}(u_{i+3}, v_{\frac{i+3}{2}})$ where $i+3$ is even.

Now if $m_l = 0$ (in particular this forces i to be even) then $h_{m_l}(u_l - u_{l-1})$ in (5.54) is nonzero if and only if $u_l = u_{l-1}$. In addition $I_{\{R_{l,m_l} = R_{l-1,m_{l-1}}\}} = 1$ if and only if $R_{l,m_l} = R_{l-1,m_{l-1}}$. By the above construction we have that $v_{\frac{l}{2}} \in R_{l,m_l}$, and $v_{\frac{l+2}{2}} \in R_{l-1,m_{l-1}}$, i.e. $v_{\frac{l}{2}}, v_{\frac{l+2}{2}}, u_l \in R_{l,m_l}$. For $T = R_{l,m_l}$ let $T_{u_l \rightsquigarrow v_{\frac{l}{2}}}$ and $T_{u_l \rightsquigarrow v_{\frac{l+2}{2}}}$ denote the backbones in T joining the specified vertices. Then there exists a unique $w_l \in T$ such that

$$T_{u_l \rightsquigarrow v_{\frac{l}{2}}} \cap T_{u_l \rightsquigarrow v_{\frac{l+2}{2}}} = T_{u_l \rightsquigarrow w_l}. \quad (5.55)$$

Collecting the above statements we have that

$$\begin{aligned}
& \sum_{R_0 \in \mathcal{T}(o)} W(R_0) \prod_{\substack{1 \leq i \leq 2N-1: \\ m_i \neq 0}} \left(\sum_{R_{i,m_i} \in \mathcal{T}(u_i)} W(R_{i,m_i}) \right) \left(I_{\{m_i \neq 0\}} + I_{\{m_i = 0\}} I_{\{R_{i,m_i} = R_{i-1,m_{i-1}}\}} \right) \times \\
& I_{\{R_0 \cap R_{2,m_2} \neq \emptyset\}} I_{\{R_{2N-3,m_{2N-3}} \cap R_{2N-1,m_{2N-1}} \neq \emptyset\}} \prod_{l=1}^{N-2} I_{\{R_{2l-1,m_{2l-1}} \cap R_{2l+2,m_{2l+2}} \neq \emptyset\}} \\
& \leq \sum_{\vec{v}} \sum_{R_0 \in \mathcal{T}(o,v_1)} W(R_0) \sum_{R_{2N-1,m_{2N-1}} \in \mathcal{T}(x,v_N)} W(R_{2N-1,m_{2N-1}}) \prod_{l:m_l=0} \sum_{R_{l,m_l} \in \mathcal{T}(u_l,v_{\frac{l}{2}},v_{\frac{l+2}{2}})} W(R_{l,m_l}) \times \\
& \prod_{\substack{l:m_l \neq 0 \\ m_{l+1} \neq 0}} \left[\left(\sum_{R_{l,m_l} \in \mathcal{T}(u_l,v_{\frac{l}{2}})} W(R_{l,m_l}) \right) I_{\{l \text{ even}\}} + \left(\sum_{R_{l,m_l} \in \mathcal{T}(u_l,v_{\frac{l+3}{2}})} W(R_{l,m_l}) \right) I_{\{l \text{ odd}\}} \right]. \tag{5.56}
\end{aligned}$$

Now observe that $\sum_{R \in \mathcal{T}(y_1,y_2)} W(R) = \rho(y_2 - y_1)$ and

$$\begin{aligned}
\sum_{R_{l,m_l} \in \mathcal{T}(u_l,v_{\frac{l}{2}},v_{\frac{l+2}{2}})} W(R_{l,m_l}) & \leq \sum_{w_l} \sum_{R_1 \in \mathcal{T}(u_l,w_l)} W(R_1) \sum_{R_2 \in \mathcal{T}(w_l,v_{\frac{l}{2}})} W(R_2) \sum_{R_3 \in \mathcal{T}(w_l,v_{\frac{l+2}{2}})} W(R_3) \\
& = \sum_{w_l} \rho(w_l - u_l) \rho(v_{\frac{l}{2}} - w_l) \rho(v_{\frac{l+3}{2}} - w_l). \tag{5.57}
\end{aligned}$$

This completes the proof of (5.42), and hence Proposition 5.7. \square

5.4 Diagram pieces

In this section we first prove Lemma 5.4 assuming the following two lemmas, which we prove later in this section.

Lemma 5.8. *Let $k \in \{1, 2, 3, 4\}$ and $\vec{r}^{(k)} \in \{0, 1\}^k$ be such that $k + \sum_{i=1}^k r_i \leq 4$, then there exists $C > 0$, which may depend on k, \vec{r} and d , such that*

$$\sum_{0 \leq |x| \leq \sqrt{m}L} \phi_{\vec{r}^{(k)}}^{(k)}(x) \leq C m^{k + \sum r_j} \sigma^{k\nu + 2 \sum r_j}, \quad \text{and} \quad \sup_{|x| > \sqrt{m}L} \phi_{\vec{r}^{(k)}}^{(k)}(x) \leq \frac{C \sigma^2 \sum r_j \beta^{2 - \frac{2k\nu}{d}}}{m^{\frac{d-2k-2 \sum r_j}{2}}}. \tag{5.58}$$

Let $[x] = |x| \vee 1$. In order to prove Lemma 5.8, we will need the following convolution result which is proved in [8].

Proposition 5.9 ([8] Prop. 1.7(i)). *If functions f, g on \mathbb{Z}^d satisfy $|f(x)| \leq [x]^{-a}$ and $|g(x)| \leq [x]^{-b}$ with $a \geq b > 0$, then there exists a constant C depending on a, b, d such that*

$$|f * g(x)| \leq \begin{cases} C[x]^{-b}, & \text{if } a > d \\ C[x]^{d-a-b}, & \text{if } a < d \text{ and } a + b > d. \end{cases} \tag{5.59}$$

Lemma 5.10. *Suppose the bounds (3.24) hold for $1 \leq m \leq n$ and $z \in [0, 2]$. Then for all $z \in [0, 2]$, $l \geq 1$, $\vec{q} \in \{0, 1\}^l$ and $\vec{m}^{(l)} \in \mathbb{Z}_+^l$ such that $\sum m_i = m \leq n + 1$, there exists $C > 0$ which may depend on l , \vec{q} and d such that*

$$\|s_{\vec{m}^{(l)}, \vec{q}^{(l)}}^{(l)}\|_\infty \leq \frac{C\sigma^2 \sum q_i \beta^2 m^{\sum q_i}}{m^{\frac{d}{2}}}, \quad \text{and } \|s_{\vec{m}^{(l)}, \vec{q}^{(l)}}^{(l)}\|_1 \leq C\sigma^2 \sum q_i m^{\sum q_i}. \quad (5.60)$$

5.4.1 Proof of Lemma 5.4

Clearly in view of Lemma 5.10 we need only prove the first inequality with $k \geq 1$.

By definition $\|s_{\vec{m}^{(l)}, \vec{q}^{(l)}}^{(l)} * \phi_{\vec{r}^{(k)}}^{(k)}\|_\infty$ is equal to $\sup_x \sum_u s_{\vec{m}^{(l)}, \vec{q}^{(l)}}^{(l)}(x-u) \phi_{\vec{r}^{(k)}}^{(k)}(u)$ which is equal to

$$\begin{aligned} & \sup_x \sum_{|u| > \sqrt{mL}} s_{\vec{m}^{(l)}, \vec{q}^{(l)}}^{(l)}(x-u) \phi_{\vec{r}^{(k)}}^{(k)}(u) + \sup_x \sum_{|u| \leq \sqrt{mL}} s_{\vec{m}^{(l)}, \vec{q}^{(l)}}^{(l)}(x-u) \phi_{\vec{r}^{(k)}}^{(k)}(u) \\ & \leq \sup_{|u'| > \sqrt{mL}} \phi_{\vec{r}^{(k)}}^{(k)}(u') \sum_{|u| > \sqrt{mL}} s_{\vec{m}^{(l)}, \vec{q}^{(l)}}^{(l)}(x-u) + \sup_{x'} s_{\vec{m}^{(l)}, \vec{q}^{(l)}}^{(l)}(x') \sum_{|u| \leq \sqrt{mL}} \phi_{\vec{r}^{(k)}}^{(k)}(u) \\ & \leq \frac{C\sigma^2 \sum r_j \beta^{2-\frac{2k\nu}{d}}}{m^{\frac{d-2k-2\sum r_j}{2}}} C\sigma^2 \sum q_i m^{\sum q_i} + \frac{C\sigma^2 \sum q_i \beta^2 m^{\sum q_i}}{m^{\frac{d}{2}}} C m^{k+\sum r_j} \sigma^{k\nu+2\sum r_j}, \end{aligned} \quad (5.61)$$

where we have applied Lemma (5.8) and Lemma (5.10) in the last step. Collecting terms we get the result. \square

5.4.2 Proof of Lemma 5.8

We first prove by induction on $k \geq 1$ that for k and \vec{r} as in the lemma,

$$\phi_{\vec{r}^{(k)}}^{(k)}(x) \leq \sum_{j=0}^k \frac{C}{L^{j(2-\nu)} [x]^{d-2j-2\sum r_i}}. \quad (5.62)$$

For $k = 1$ (5.62) for $\vec{r}^{(1)} \in \{0, 1\}$ follows easily from (1.4). For $k > 1$ we write

$$\phi_{\vec{r}^{(k)}}^{(k)}(x) = \sum_u \phi_{r_1}^{(1)}(u) \phi_{(r_2, \dots, r_k)}^{(k-1)}(x-u) \leq \sum_{j=0}^1 \sum_{n=0}^{k-1} \frac{C}{L^{(j+n)(2-\nu)}} \frac{C}{[x]^{d-2(j+n)-2\sum_{i=1}^k r_i}}, \quad (5.63)$$

using the induction hypothesis with Proposition 5.9 and the fact that $k + \sum r_i < 4$ in the last step. With a different constant, (5.63) is bounded by

$$\sum_{j=0}^k \frac{C}{L^{j(2+\nu)} [x]^{d-2j-2\sum_{i=1}^k r_i}}$$

as required.

Therefore we have

$$\sum_{0 \leq |x| \leq \sqrt{m}L} \phi_{\bar{r}^{(k)}}^{(k)}(x) \leq \sum_{j=0}^k \sum_{0 \leq |x| \leq \sqrt{m}L} \frac{C}{L^{j(2-\nu)} [x]^{d-2j-2\sum r_i}} \leq \sum_{j=0}^k \frac{C (\sqrt{m}L)^{2j+2\sum r_i}}{L^{j(2-\nu)}} \leq C m^{k+\sum r_i} \sigma^{k\nu+2\sum r_i} \quad (5.64)$$

which proves the first bound of Lemma 5.8. Similarly,

$$\sup_{|x| > \sqrt{m}L} \phi_{\bar{r}^{(k)}}^{(k)}(x) \leq \sum_{j=0}^k \sup_{|x| > \sqrt{m}L} \frac{C}{L^{j(2-\nu)} [x]^{d-2j-2\sum r_i}} \leq \sum_{j=0}^k \frac{C}{L^{j(2-\nu)} (\sqrt{m}L)^{d-2j-2\sum r_i}} \leq \frac{C \sigma^2 \sum r_j \beta^{2-\frac{2k\nu}{d}}}{m^{\frac{d-2k-2\sum r_j}{2}}}, \quad (5.65)$$

which proves the second bound of Lemma 5.8. \square

5.4.3 Proof of Lemma 5.10

We prove the result by induction on l .

For $l = 1$ we use induction on m . For $l = 1$ and $m = 1$ we have $h_1(x) = \zeta p_c D(x)$ and hence

$$\|h_1\|_\infty \leq \frac{C}{L^d} = C\beta^2, \quad \|h_1\|_1 \leq C.$$

Using the fact that $D(x) = 0$ for $|x|^2 > dL^2$,

$$\sup_x |x|^2 h_1(x) \leq CL^2 \frac{1}{L^d} \leq C\sigma^2 \beta^2,$$

and by (3.19)

$$\sum_x |x|^2 h_1(x) \leq C \sum_x |x|^2 D(x) \leq C\sigma^2.$$

This proves the result for the case $l = 1, m = 1$.

The cases $l = 1$ and $m \leq 6$ are dealt with as follows

$$\begin{aligned} h_m(x) &= \sum_{u,v} D(u)D(v-u)t_{m-2}(x-v) \leq CL^{-d} \sum_u D(u) \sum_v t_{m-2}(x-v) \leq C\beta^2 \leq \frac{C\beta^2}{m^{\frac{d}{2}}} \\ |x|^2 h_m(x) &= \sum_{u,v} |x|^2 D(u)D(v-u)t_{m-2}(x-v) \\ &\leq CL^2 \sum_{u,v} D(u)D(v-u)t_{m-2}(x-v) + CL^{-d} \sum_{u,v} D(u)|x-v|^2 t_{m-2}(x-v) \leq \frac{C\sigma^2 \beta^2}{m^{\frac{d}{2}}}, \end{aligned} \quad (5.66)$$

where we have used the assumed bounds (3.24) and the fact that $m \leq m_0 = 6$ in the last step in each case. Similarly using the assumed bounds (3.24) we have for all $m \leq n+1$,

$$\begin{aligned} \sum_x h_m(x) &= \sum_u D(u) \sum_v D(v-u) \sum_x t_{m-2}(x-v) \leq K \\ \sum_x |x|^2 h_m(x) &\leq C \sum_{u,v} D(u)D(v-u) \left[L^2 \sum_x t_{m-2}(x-v) + \sum_x |x-v|^2 t_{m-2}(x-v) \right] \leq C\sigma^2 m. \end{aligned} \quad (5.67)$$

For $l = 1$ and $2m \geq 6$ we write

$$h_{2m}(x) \leq C(h_m * h_m)(x) \leq C\|h_m\|_2^2 = C\|\widehat{h}_m\|_2^2 \leq \frac{C\beta^2}{(2m)^{\frac{d}{2}}}, \quad (5.68)$$

where we have used Parseval's equality and the assumed bounds (3.24). Similarly for $l = 1$ and $2m + 1 \geq 7$ we write $h_{2m+1}(x) \leq C(D * h_m * h_m)(x)$ and proceed as in (5.68). This establishes the result for $l = 1$, and all $m \leq n + 1$ when $q = 0$. Using this result with (3.24) it follows that

$$|x|^2 h_{2m}(x) \leq C \sum_u |u|^2 h_m(u) h_m(x-u) + C \sum_u h_m(u) |x-u|^2 h_m(x-u) \leq \frac{C\beta^2}{(2m)^{\frac{d}{2}}} K\sigma^2 m, \quad (5.69)$$

and similarly for $|x|^2 h_{2m+1}(x)$. This completes the proof for $l = 1$.

For $l \geq 2$ we have $s_{\vec{m}^{(l)}, \vec{q}^{(l)}}^{(l)} = \sum_u s_{m_1, q_1}^{(1)}(u) s_{(m_2, \dots, m_l), (q_2, \dots, q_l)}^{(l-1)}(x-u)$. If $m_1 \geq \frac{m}{2}$,

$$\|s_{\vec{m}^{(l)}, \vec{q}^{(l)}}^{(l)}\|_\infty \leq \|s_{m_1, q_1}^{(1)}\|_\infty \|s_{(m_2, \dots, m_l), (q_2, \dots, q_l)}^{(l-1)}\|_1 \leq \frac{C\sigma^{2q_1} \beta^2 m^{q_1}}{m^{\frac{d}{2}}} C\sigma^{2\sum_{i=2}^l q_i} m^{\sum_{i=2}^l q_i} \leq \frac{C\sigma^2 \sum q_i m^{\sum q_i} \beta^2}{m^{\frac{d}{2}}}, \quad (5.70)$$

as required. Similarly if $m_1 < \frac{m}{2}$,

$$\|s_{\vec{m}^{(l)}, \vec{q}^{(l)}}^{(l)}\|_\infty \leq \|s_{m_1, q_1}^{(1)}\|_1 \|s_{(m_2, \dots, m_l), (q_2, \dots, q_l)}^{(l-1)}\|_\infty \leq C\sigma^{2q_1} m^{q_1} \frac{C\sigma^{2\sum_{i=2}^l q_i} \beta^2 m^{\sum_{i=2}^l q_i}}{m^{\frac{d}{2}}} \leq \frac{C\sigma^2 \sum q_i m^{\sum q_i} \beta^2}{m^{\frac{d}{2}}}, \quad (5.71)$$

as required. This completes the proof of the first bound of Lemma 5.10 for all l .

For the second bound of Lemma 5.10, we have

$$\|s_{\vec{m}^{(l)}, \vec{q}^{(l)}}^{(l)}\|_1 \leq \|s_{m_1, q_1}^{(1)}\|_1 \|s_{(m_2, \dots, m_l), (q_2, \dots, q_l)}^{(l-1)}\|_1 \leq C\sigma^{2q_1} m^{q_1} C\sigma^{2\sum_{i=2}^l q_i} m^{\sum_{i=2}^l q_i} \leq C\sigma^2 \sum_{i=1}^l q_i m^{\sum_{i=1}^l q_i}, \quad (5.72)$$

as required. This completes the proof of the second bound of Lemma 5.10, and thus completes the proof of Lemma 5.10. \square

5.5 Diagrams with an extra vertex

Now that the induction proof has been completed, all of the previous diagrammatic bounds hold for all m when $L \geq L_0$.

We say that a diagram B has an extra vertex (than A) on some ρ if A and B are the same diagram except that one component $\rho(z)$ in diagram A is replaced with $\rho^{(2)}(z)$ in B . We say that a diagram B has an extra vertex (than A) on some h_m if A and B are the same diagram except that one component $h_{m_j}(z)$ in diagram A is replaced with $h_{m'} * h_{m_j - m'}(z)$ in B . When we consider the diagrams arising from the lace expansion on a star-shape of degree 3 we will encounter diagrams with an extra vertex on some ρ or h_m . We bound the contribution from all such diagrams by repeating the inductive analysis used in the proof of Proposition 5.1. We do not show all the details but the main ideas are as follows.

We let n denote the location along the branch where the extra vertex is located. If $n = \sum_{i=1}^j m_i$ for some $1 \leq j \leq 2N - 2$ then the extra vertex is on the ρ emanating from the backbone at n , or a ρ incident to that ρ (of which there are at most two). If $n = 0$ (resp. $n = m$) then the extra vertex is on the first ρ (resp. last ρ) in the diagram, or the ρ incident to it. Otherwise the extra vertex is at position n on the backbone (i.e. on some h_{m_i}). Given $M_{\vec{m}}^{(N)}(a, b, x, y)$, let $M_{\vec{m}}^{(N),n}(a, b, x, y)$ denote the corresponding diagram with an extra vertex at n .

We prove by induction on N that

$$\sum_{\vec{m} \in \mathcal{H}_m^N} \sum_{n \leq m} \sup_{a,b,y} \sum_x M_{\vec{m}}^{(N),n}(a, b, x, y) \leq \frac{(C\beta^{2-\frac{8\nu}{d}})^N}{m^{\frac{d-6}{2}}}, \quad (5.73)$$

For $N = 1$ the left hand side of (5.73) is

$$\sum_{0 < n < m} \sup_{a,b,y} \sum_x (h_n * h_{m-n})(x-a)\rho^{(2)}(x+y-b) + 2 \sup_{a,b,y} \sum_x h_m(x-a)\rho^{(3)}(x+y-b). \quad (5.74)$$

Using (5.5) with $l = 2$, $k = 2$ and all $q_i, r_j = 0$, the first term in (5.74) is bounded by

$$\sum_{0 < n < m} \frac{C\beta^{2-\frac{4\nu}{d}}}{m^{\frac{d-4}{2}}} \leq \frac{C\beta^{2-\frac{4\nu}{d}}}{m^{\frac{d-6}{2}}}.$$

Similarly using (5.5) with $l = 2$, $k = 3$ and all $q_i, r_j = 0$, the second term is bounded by $C\beta^{2-\frac{6\nu}{d}} m^{-\frac{d-6}{2}}$. Adding these together we get a bound of $C\beta^{2-\frac{6\nu}{d}} m^{-\frac{d-6}{2}}$ which satisfies the first bound of the induction hypothesis with $N = 1$.

For general $N \geq 2$ we bound

$$\sum_{\vec{m} \in E_m^N} \sum_{n \leq m} \sup_{a,b,y} \sum_x M_{\vec{m}}^{(N),n}(a, b, x, y),$$

by using (5.8), and splitting the sum over $n \leq m$ into sums over $n \leq m_1 + m_2 : n \neq m_1$, and $n > m_1 + m_2$, and the final case $n = m_1$. In each case the extra vertex is either on A_{m_1, m_2} or $M_{\vec{m}'}^{(N-1)}$. In the former case we use the $q = 0$ result in the proof of Proposition 5.1 on the $M_{\vec{m}'}^{(N-1)}$ part and (5.5) (increasing k or l by one due to the extra vertex) on the A_{m_1, m_2}^n part. In the latter case we use the induction hypothesis on the $M_{\vec{m}'}^{(N-1),n}$ part and (5.5) on the A_{m_1, m_2} part. The contributions from $\vec{m} \in F_m^N$ and $\vec{m} \in G_m^2$ are dealt with as usual.

Similarly we prove

$$\sum_{\vec{m} \in \mathcal{H}_m^N} \sum_{n \leq m} \sup_{a,b,y} \sum_x |x-a|^2 M_{\vec{m}}^{(N),n}(a, b, x, y) \leq \frac{\sigma^2 (C\beta^{2-\frac{8\nu}{d}})^N}{m^{\frac{d-8}{2}}}. \quad (5.75)$$

Note the factor $|x-a|^2$ in (5.75) rather than $|\bar{z}|$ or $|z|$. This is to avoid the situation that could arise of having a convolution of four ρ 's with one of them having an extra factor $|u|^2$ on the same diagram piece. This would violate the condition $k + \sum_{i=1}^k r_i \leq 4$ in Proposition 5.4. Using $|x-a|^2$ instead, we will use the path along the backbone from a to x rather than the top path or bottom path, and the induction argument goes through as before.

6 Diagrams for the 3-point function

In this section we bound the diagrams arising from minimal laces on a star shape $\mathcal{S}_{\vec{M}}$ of degree 3, in order to bound the left hand side of (4.31) when $q = 0$. In an attempt to minimize the size of an already large paper, we do not give as many details as in Section 5. As in the case of the two-point function, one can prove an explicit upper bound for the contribution to (4.29) from minimal laces in terms of diagrams consisting of convolutions of ρ and h_{m_i} using the definition of a lace L and the fact that any bond $b_1 \notin L$ that is covered by a bond $b_2 \in L$ is compatible with L . The formula is long and the notation becomes messy, so that such a formula is not particularly informative. For fixed N , fixed N_1 and N_2 (the number of bonds strictly on branch 1 and 2 respectively) and fixed topology of bonds covering the branchpoint (plus one extra bond in some cases), minimal laces are in 1-1 correspondence with collections $\vec{m}_l, \vec{m}_t, \vec{m}_r$. The \vec{m} indicate vertices along the backbones of each branch at which there are lattice trees intersecting the lattice trees emanating from other such vertices.

The essential idea that one should take from this section is that there is a finite collection of basic diagrams $D_{\vec{M}}^{(j)}$, such that all diagrams arising from laces on $\mathcal{S}_{\vec{M}}$ can be described recursively by connecting (to some $D_{\vec{M}}^{(j)}$) subdiagrams of the form $A_{\cdot}(\cdot, \cdot, \cdot, \cdot)$ as in (5.7–5.8). These basic diagrams are the “opened diagrams” obtained from laces where all bonds cover the branch point of $\mathcal{S}_{\vec{M}}$ (such laces therefore contain at most 3 bonds), and sometimes those laces with one extra bond. Therefore the majority of this section is devoted to the bounding of the so-called basic diagrams contributing to (4.29), using decompositions of the diagrams into subdiagrams. One can of course decompose a given diagram in many different ways, obtaining many different bounds. We saw in Section 5 that the usefulness of a particular decomposition/bound depends on the relative sizes of the m_i of the h_{m_i} in a given diagram. Therefore the relevant decompositions of the basic diagrams are different depending on the topology of the lace and on the specific location of the endpoints of the bonds in each lace. They are done in such a way that the same decomposition can easily be extended to general diagrams with the same topology of bonds covering the branch point, usually due to the existing bounds that we obtained from diagrams arising from the lace expansion on an interval in Section 5.

We now proceed to estimate the diagrams arising from the lace expansion, with N , N_1 , N_2 and the topology of bonds covering the branchpoint all assumed to be fixed (hence N_3 is also fixed).

6.1 (Minimal) Acyclic laces with two bonds covering the branch point

Without loss of generality we may assume that branch 3 is a special branch for which the bond $s_3 t_3$ in L associated to branch 3 has s_3 on branch 1 and is not the bond in L associated to any other branch. We first consider the diagrams arising from acyclic laces consisting of only two bonds (see Figure 20).

The decomposition of the first diagram depends on the relative size of $M_1 - m_1$ and M_2 as

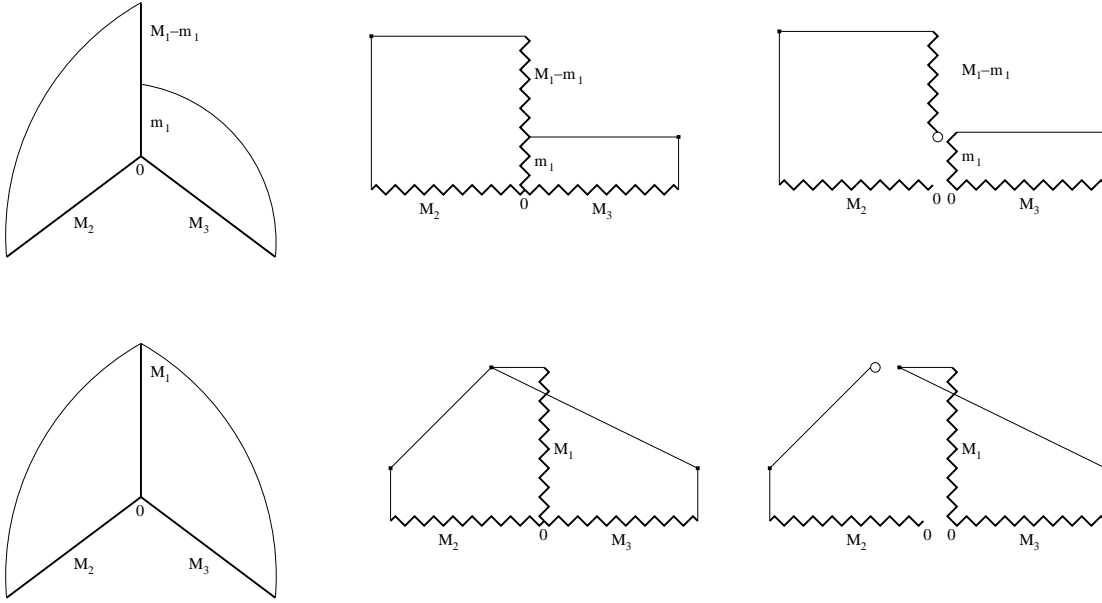

Figure 20: The two topologies of acyclic laces with 2 bonds, their corresponding diagrams and decomposition.

follows:

$$\begin{aligned}
& \sum_{m_1 < M_1} \sum_u h_{m_1}(u) \left(h_{M_2}(x_2) * \rho^{(2)} * h_{M_1-m_1} \right) (u) \left(h_{M_3} * \rho^{(2)} \right) (u) \\
& \leq \sum_{m_1 < M_1} \left(h_{m_1} * \rho^{(2)} * h_{M_3} \right) (0) \sup_{u'} \left(h_{M_2} * \rho^{(2)} * h_{M_1-m_1} \right) (u') \\
& \leq \sum_{m_1 < M_1} \left(h_{m_1} * \rho^{(2)} * h_{M_3} \right) (0) \begin{cases} \sup_{u'} \sum_{x_1} h_{M_1-m_1}(x_1 - u') \sup_{x'_1} \left(h_{M_2} * \rho^{(2)} \right) (x'_1), & M_2 \geq M_1 - m_1 \\ \sup_{u'} \sum_{x_2} h_{M_2}(x_2) \sup_{x'_2} \left(h_{M_2} * \rho^{(2)} * h_{M_1-m_1} \right) (x'_2 - u'), & M_2 < M_1 - m_1 \end{cases} \\
& \leq \sum_{m_1 < M_1} \frac{C\beta^{2-\frac{4\nu}{d}}}{[m_1 + M_3]^{\frac{d-4}{2}}} K \frac{C\beta^{2-\frac{4\nu}{d}}}{[M_2 \vee (M_1 - m_1)]^{\frac{d-4}{2}}}, \tag{6.1}
\end{aligned}$$

by using Lemma 5.4 three times.

The decomposition of the second diagram depends on the relative size of M_2 and M_3 . When $M_2 \geq M_3$ we use

$$\begin{aligned}
\sum_u \left(h_{M_1} * \rho \right) (u) \left(h_{M_2} * \rho^{(2)} \right) (u) \left(h_{M_3} * \rho^{(2)} \right) (u) & \leq \left(h_{M_1} * \rho^{(3)} * h_{M_3} \right) (0) \sup_{u'} \left(h_{M_2} * \rho^{(2)} \right) (u') \\
& \leq \frac{C\beta^{2-\frac{4\nu}{d}}}{M_2^{\frac{d-4}{2}}} \frac{C\beta^{2-\frac{6\nu}{d}}}{(M_1 + M_3)^{\frac{d-6}{2}}} \leq \frac{C\beta^{2-\frac{4\nu}{d}}}{[M_2 + M_3]^{\frac{d-4}{2}}} \frac{C\beta^{2-\frac{6\nu}{d}}}{M_1^{\frac{d-6}{2}}}, \tag{6.2}
\end{aligned}$$

by using Lemma 5.4 twice.

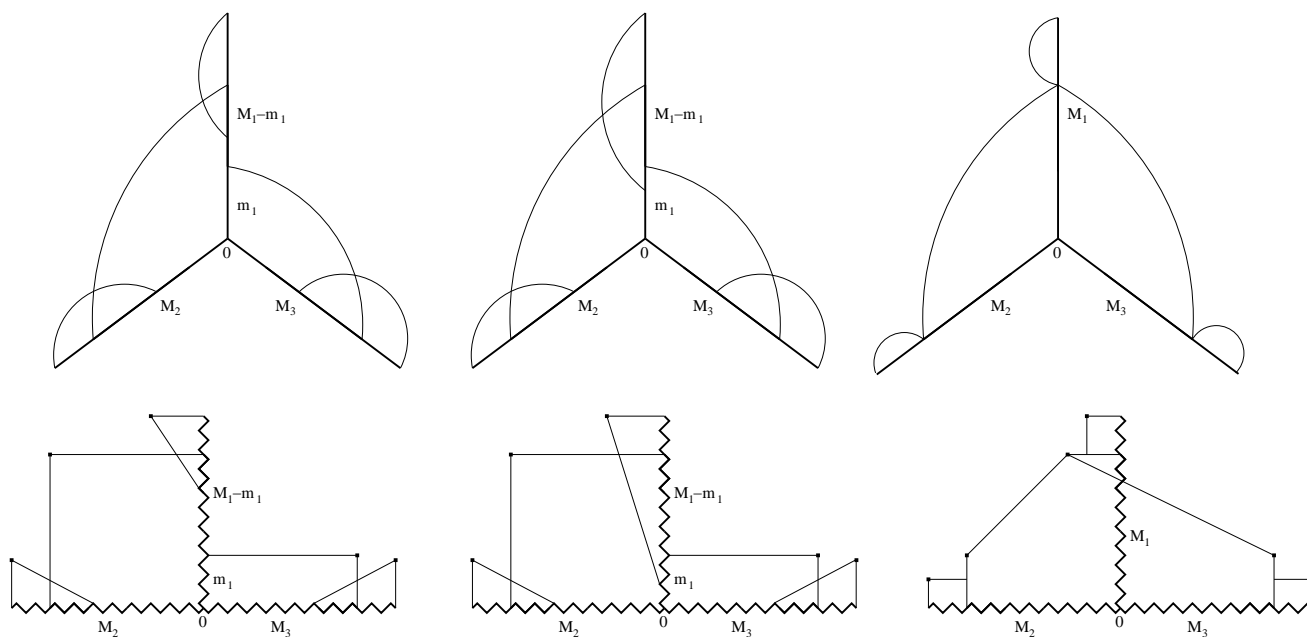

Figure 21: Three examples of acyclic laces with 2 bonds covering the branch point and more than two bonds in total and their diagrams (only one of the two topologically distinct possible diagrams for the third lace is shown).

For general acyclic laces with only two bonds covering the branch point, there may be a bond strictly on branch 1 which strictly covers, or has an endpoint the same as, one or more of the bonds covering the branch point. This gives rise to a number of different possible diagrams. We select three laces whose diagrams and associated decompositions illustrate the idea in Figure 21. When this bond exists but does not cover the endpoint on branch 1 of the bond associated to branch 3 (e.g. see the first diagram in Figure 21 and the first column of Figure 22), the decomposition is the same as the first diagram of Figure 20 except that we use the bounds on diagrams in Section 5 rather than just using Lemma 5.4. In doing so we obtain a bound on the contribution from such laces of

$$\sum_{m_1 < M_1} \frac{(C\beta^{2-\frac{4\nu}{d}})^{N_3+1}}{[m_1 + M_3]^{\frac{d-4}{2}}} K(C\beta^{2-\frac{4\nu}{d}})^{N_2} \frac{(C\beta^{2-\frac{4\nu}{d}})^{N_1+1}}{[M_2 \vee (M_1 - m_1)]^{\frac{d-4}{2}}} \leq \frac{(C\beta^{2-\frac{4\nu}{d}})^N}{(M_1 + M_3)^{\frac{d-4}{2}} M_2^{\frac{d-6}{2}}} + \frac{(C\beta^{2-\frac{4\nu}{d}})^N}{M_3^{\frac{d-6}{2}} (M_2 + M_1)^{\frac{d-6}{2}}}, \quad (6.3)$$

when $M_1 - m_1 \geq M_2$ (see the first diagram of Figure 22), and the same bound (but with N_2 and N_1 switched) when $M_1 - m_1 < M_2$. Note that we have broken the sum over m_1 into the regions $m_1 \geq M_1/2$ and $M_1 - m_1 \geq M/2$ to obtain the last expression.

When there is a bond strictly on branch 1 that strictly covers endpoints of both bonds covering the branchpoint (e.g. see the second diagram in Figure 21 and the second column of Figure 22), the decomposition changes slightly, where it now depends on the relative size of M_2 and M_3 . This decomposition gives the bound

$$\frac{(C\beta^{2-\frac{4\nu}{d}})^N}{[M_2 \vee M_3]^{\frac{d-4}{2}}} \sum_{m_1 \leq M_1} \frac{1}{[M_1 + (M_2 \wedge M_3)]^{\frac{d-4}{2}}} \leq \frac{(C\beta^{2-\frac{4\nu}{d}})^N}{[M_2 \vee M_3]^{\frac{d-4}{2}}} \frac{1}{M_1^{\frac{d-6}{2}}}, \quad (6.4)$$

where $N = N_2 + 1 + (N_1 + N_3 + 1) = N_3 + 1 + (N_1 + N_2 + 1)$.

When there is a bond strictly on branch 1 that shares an endpoint with one or both of the bonds covering the branch point, the corresponding diagrams can all be decomposed in a similar fashion. The decompositions give rise to subdiagrams that are exactly one of those arising from laces on an interval, or such a diagram with an extra vertex on some ρ . Since we have appropriate bounds on such diagrams this brings no new difficulties and therefore we do not present all cases. An example of this is the third lace of Figure 21, which is decomposed according to whether M_2 or M_3 is larger as in the third column of Figure 22. This gives a bound of

$$\frac{(C\beta^{2-\frac{4\nu}{d}})^N}{[M_2 \vee M_3]^{\frac{d-4}{2}}} \frac{1}{[M_1 + (M_2 \wedge M_3)]^{\frac{d-6}{2}}} \leq \frac{(C\beta^{2-\frac{4\nu}{d}})^N}{[M_2 \vee M_3]^{\frac{d-4}{2}}} \frac{1}{M_1^{\frac{d-6}{2}}}, \quad (6.5)$$

where $N = N_2 + 1 + (N_1 + N_3 + 1) = N_3 + 1 + (N_1 + N_2 + 1)$ and we have used the bounds for a diagram with an extra vertex on some ρ as in Section 5.5. In general our bound on the diagrams arising from acyclic laces consisting of N bonds (with N_1 and N_2 fixed) with two bonds covering the branchpoint, is a sum over permutations of branch labels and of all the bounds listed above, with precisely N factors of $C\beta^{2-\frac{8\nu}{d}}$.

6.2 (Minimal) Acyclic laces with 3 bonds covering the branch point

Figure 23 shows the topologies of the (minimal) acyclic laces consisting of exactly 3 bonds covering the branch point, while Figure 24 shows the diagrams arising from these acyclic laces.

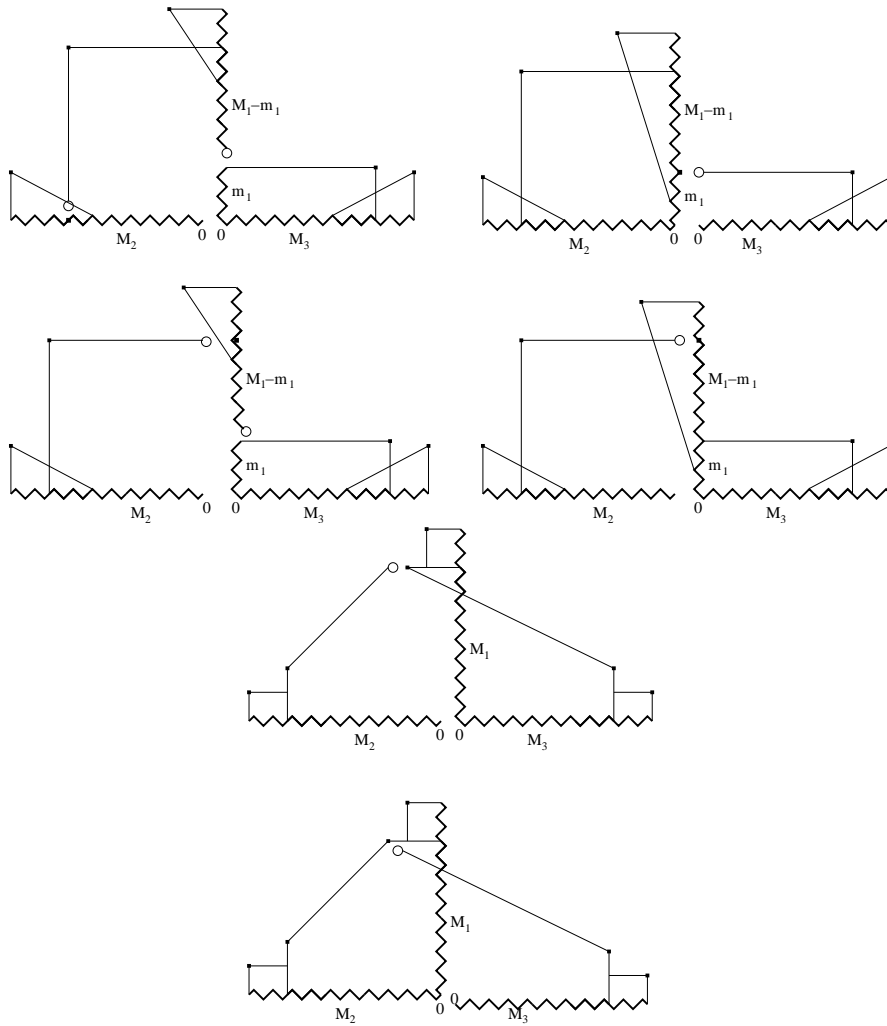

Figure 22: The first (resp. second, third) column shows the decompositions of the first (resp. second third) diagram of Figure 21. Apart from the second column, these are the same as the decompositions in Figure 20.

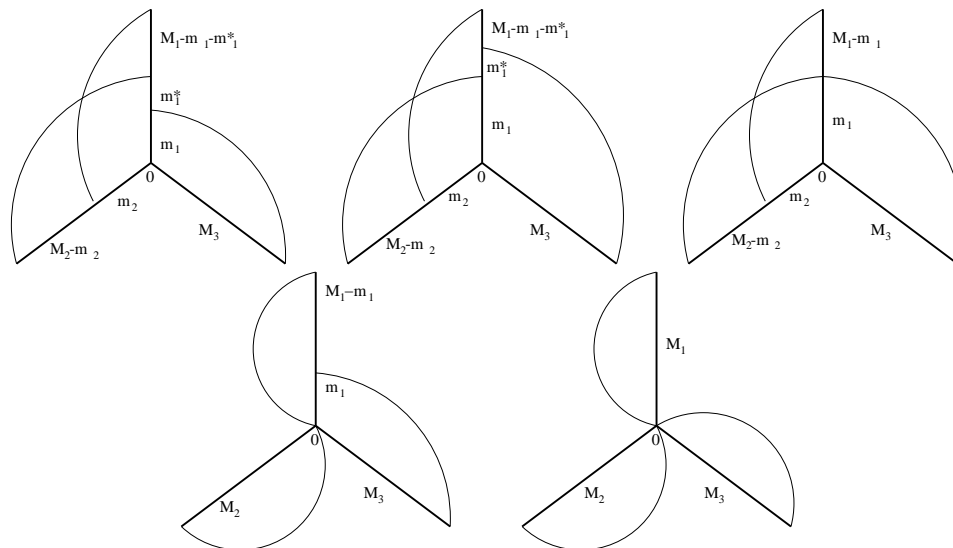

Figure 23: The 5 different topologies (exhaustive up to permutations of branch labels) for acyclic laces with 3 bonds covering the branch point.

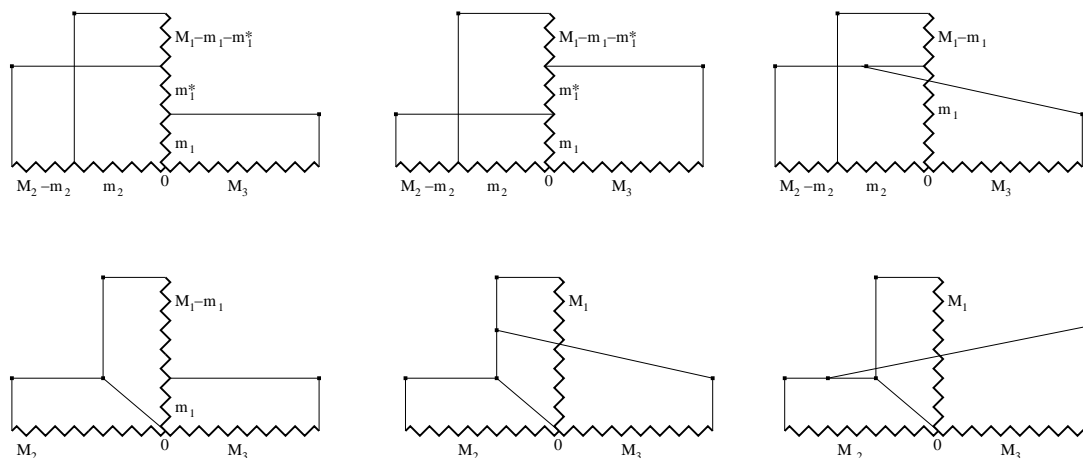

Figure 24: The three different diagrams for acyclic laces with 3 bonds (at least two strictly) covering the branch point (see the top row of Figure 23), followed by the diagram arising from the acyclic laces with 3 bonds (exactly one strictly) covering the branch point (bottom left lace of Figure 23) and the two diagrams arising when all three bonds meet at the branch point (bottom right lace of Figure 23).

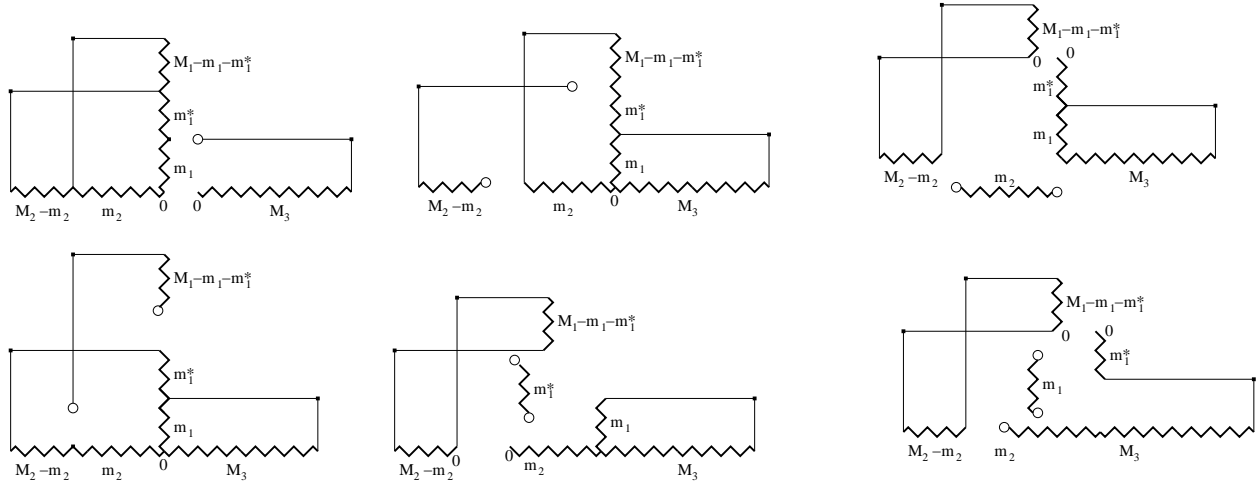

Figure 25: The decomposition of the first diagram in Figure 24 into subdiagrams depending on which of M_3 , $M_2 - m_2$, m_2 , $M_1 - m_1 - m_1^*$, m_1^* or m_1 is large.

Figure 25 shows the decomposition of the first diagram in Figure 24. The diagram is decomposed into subdiagrams depending on which of the M_i (and m_i , m_i^*) are largest.

$$\begin{aligned}
 M_3 \text{ largest : } & \frac{C\beta^{2-\frac{4\nu}{d}}}{[M]^{\frac{d-4}{2}}} \sum_{m_1 \leq M_1} \frac{(C\beta^{2-\frac{6\nu}{d}})^2}{[M_1 + M_2]^{\frac{d-4}{2}}}, \\
 M_2 \text{ largest : } & \frac{C\beta^{2-\frac{4\nu}{d}}}{[M]^{\frac{d-4}{2}}} \sum_{m_2 \leq M_2/2} \sum_{m_1^* \leq M_1} A^{(2)}(M_1, m_2, M_3) \\
 & + \frac{C\beta^2}{[M]^{\frac{d}{2}}} \sum_{m_2 \geq M_2/2} \sum_{m_1, m_1^* \leq M_1} \frac{C\beta^{2-\frac{4\nu}{d}}}{[m_1 + M_3]^{\frac{d-4}{2}}} \frac{C\beta^{2-\frac{8\nu}{d}}}{[M_2 - m_2 + M_1 - m_1 - m_1^*]^{\frac{d-8}{2}}}, \\
 M_1 \text{ largest : } & \frac{C\beta^{2-\frac{4\nu}{d}}}{[M]^{\frac{d-4}{2}}} \sum_{m \leq 2M_1/3} \sum_{m_2 \leq M_2} A^{(2)}(m, M_2, M_3) \\
 & + \frac{C\beta^2}{[M]^{\frac{d}{2}}} \sum_{m_1^* \geq M_1/3} \sum_{m_1 \leq M_1} \sum_{m_2 \leq M_2} \frac{C\beta^{2-\frac{4\nu}{d}}}{[m_1 + M_3]^{\frac{d-4}{2}}} \frac{C\beta^{2-\frac{8\nu}{d}}}{[M_1 - m_1 - m_1^* + M_2 - m_2]^{\frac{d-8}{2}}} \\
 & + \frac{C\beta^2}{[M]^{\frac{d}{2}}} \sum_{m_1 \geq M_1/3} \sum_{m_1^* \leq M_1} \sum_{m_2 \leq M_2} \frac{C\beta^{2-\frac{4\nu}{d}}}{[m_1^* + m_2 + M_3]^{\frac{d-4}{2}}} \frac{C\beta^{2-\frac{8\nu}{d}}}{[M_1 - m_1 - m_1^* + M_2 - m_2]^{\frac{d-8}{2}}}.
 \end{aligned} \tag{6.6}$$

Here (and elsewhere in this section), $A^{(2)}(m_1, m_2, m_3)$ denotes the bound on diagrams arising from acyclic laces on $\mathcal{S}_{\vec{m}}$ containing exactly two bonds.

Figure 26 shows the decomposition of the second diagram in Figure 24. The diagram is decom-

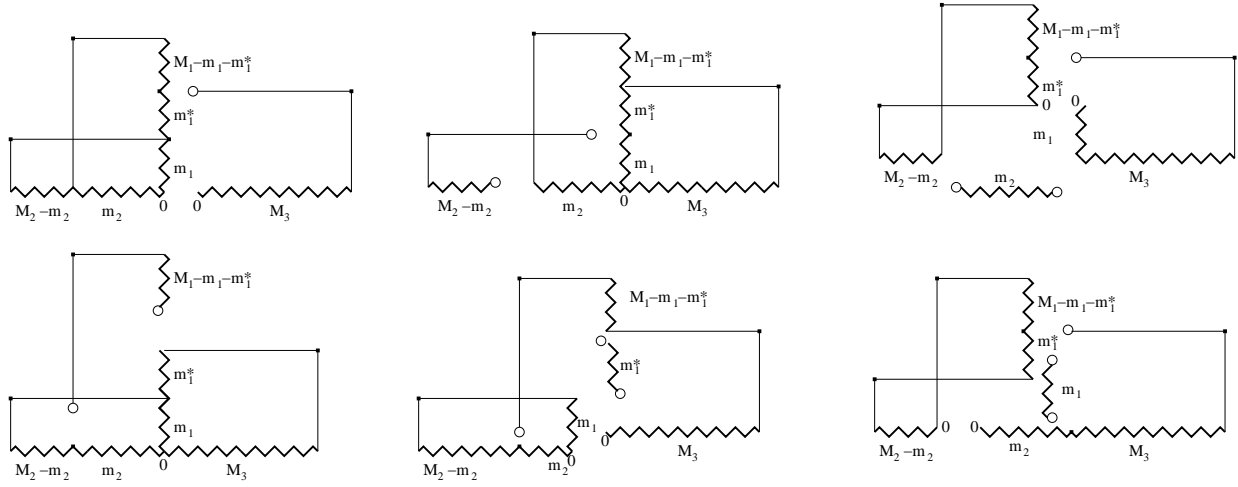

Figure 26: The decomposition of the second diagram in Figure 24 into subdiagrams depending on which of M_3 , $M_2 - m_2$, m_2 , $M_1 - m_1 - m_1^*$, m_1^* or m_1 is largest.

posed into subdiagrams depending on which of the M_i (and m_i , m_i^*) are largest.

$$\begin{aligned}
 M_3 \text{ largest : } & \frac{C\beta^{2-\frac{4\nu}{d}}}{[M]^{\frac{d-4}{2}}} \sum_{m_1^* \leq M_1} \frac{(C\beta^{2-\frac{6\nu}{d}})^2}{[M_1 + M_2]^{\frac{d-4}{2}}}, \\
 M_2 \text{ largest : } & \frac{C\beta^{2-\frac{4\nu}{d}}}{[M]^{\frac{d-4}{2}}} \sum_{m_2 \leq M_2/2} \sum_{m_1 \leq M_1} A^{(2)}(M_1, m_2, M_3) \\
 & + \frac{C\beta^2}{[M]^{\frac{d}{2}}} \sum_{m_2 \geq M_2/2} \sum_{m_1, m_1^* \leq M_1} \frac{C\beta^{2-\frac{4\nu}{d}}}{[m_1 + M_3]^{\frac{d-4}{2}}} \frac{C\beta^{2-\frac{8\nu}{d}}}{[M_2 - m_2 + M_1 - m_1]^{\frac{d-8}{2}}}, \\
 M_1 \text{ largest : } & \frac{C\beta^{2-\frac{4\nu}{d}}}{[M]^{\frac{d-4}{2}}} \sum_{m \leq 2M_1/3} \sum_{m_2 \leq M_2} A^{(2)}(m, M_2, M_3) \\
 & + \frac{C\beta^2}{[M]^{\frac{d}{2}}} \sum_{m_1^* \geq M_1/3} \sum_{m_1 \leq M_1} \sum_{m_2 \leq M_2} \frac{C\beta^{2-\frac{4\nu}{d}}}{[m_1 + M_2]^{\frac{d-4}{2}}} \frac{C\beta^{2-\frac{8\nu}{d}}}{[M_1 - m_1 - m_1^* + M_3]^{\frac{d-8}{2}}} \\
 & + \frac{C\beta^2}{[M]^{\frac{d}{2}}} \sum_{m_1 \geq M_1/3} \sum_{m_1^* \leq M_1} \sum_{m_2 \leq M_2} \frac{C\beta^{2-\frac{4\nu}{d}}}{[m_2 + M_3]^{\frac{d-4}{2}}} \frac{C\beta^{2-\frac{8\nu}{d}}}{[M_1 - m_1 - m_1^* + M_2 - m_2]^{\frac{d-8}{2}}}.
 \end{aligned} \tag{6.7}$$

Figure 27 shows the decomposition of the third diagram in Figure 24. The diagram is decomposed into subdiagrams depending on which of the M_i (and m_i) are largest. When m_1 is the

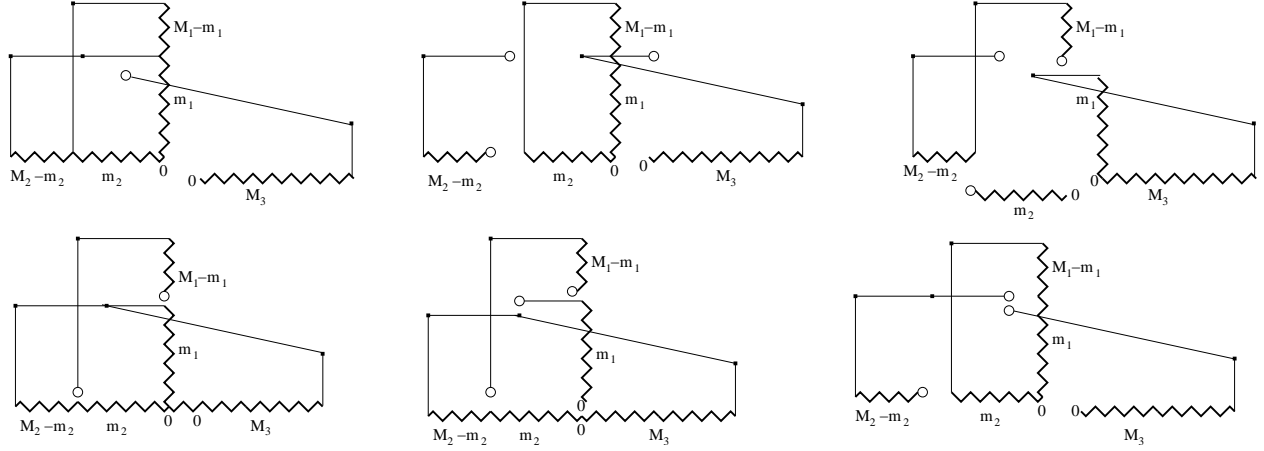

Figure 27: The decomposition of the third diagram in Figure 24 into subdiagrams depending on which of M_3 , $M_2 - m_2$, m_2 , $M_1 - m_1$, or m_1 is largest.

largest we choose a decomposition depending on which of M_3 or $M_1 - m_1$ is larger.

$$\begin{aligned}
M_3 \text{ largest : } & \frac{C\beta^{2-\frac{4\nu}{d}}}{[M]^{\frac{d-4}{2}}} \frac{(C\beta^{2-\frac{6\nu}{d}})^2}{[M_1 + M_2]^{\frac{d-6}{2}}} \\
M_2 \text{ largest : } & \frac{C\beta^{2-\frac{4\nu}{d}}}{[M]^{\frac{d-4}{2}}} \sum_{m_2 \leq M_2/2} \sum_{m_1 \leq M_1} \frac{C\beta^{2-\frac{4\nu}{d}}}{[M_3]^{\frac{d-6}{2}}} \frac{C\beta^{2-\frac{4\nu}{d}}}{[M_1 + m_2]^{\frac{d-4}{2}}} \\
& + \frac{C\beta^2}{[M]^{\frac{d}{2}}} \sum_{m_2 \geq M_2/2} \sum_{m_1 \leq M_1} \frac{C\beta^{2-\frac{6\nu}{d}}}{[m_1 + M_3]^{\frac{d-6}{2}}} \frac{C\beta^{2-\frac{8\nu}{d}}}{[M_2 - m_2 + M_1 - m_1]^{\frac{d-8}{2}}}, \\
M_1 \text{ largest : } & \frac{C\beta^{2-\frac{4\nu}{d}}}{[M]^{\frac{d-4}{2}}} \sum_{m_1 \leq M_1} \sum_{m_2 \leq M_2} A^{(2)}(m_1, M_2, M_3) \\
& + \frac{C\beta^{2-\frac{2\nu}{d}}}{[M]^{\frac{d-2}{2}}} \sum_{\substack{m_1 \geq M_1/2: \\ M_1 - m_1 \geq M_3}} \sum_{m_2 \leq M_2} \frac{C\beta^{2-\frac{4\nu}{d}}}{[M_1 - m_1]^{\frac{d-4}{2}}} \frac{C\beta^{2-\frac{8\nu}{d}}}{[M_2 + M_3]^{\frac{d-8}{2}}} \\
& + \frac{C\beta^{2-\frac{4\nu}{d}}}{[M]^{\frac{d-4}{2}}} \sum_{\substack{m_1 \geq M_1/2: \\ M_1 - m_1 \leq M_3}} \sum_{m_2 \leq M_2} \frac{C\beta^{2-\frac{4\nu}{d}}}{[M_3]^{\frac{d-4}{2}}} \frac{C\beta^{2-\frac{6\nu}{d}}}{[M_2 - m_2]^{\frac{d-6}{2}}}.
\end{aligned} \tag{6.8}$$

Figure 28 shows the decomposition of the fourth, fifth and sixth diagrams in Figure 24. The resulting bounds are

$$\begin{aligned}
\text{fourth diagram, } & \frac{C\beta^{2-\frac{4\nu}{d}}}{[M_2]^{\frac{d-4}{2}}} \sum_{m_1 \leq M_1} \frac{C\beta^{2-\frac{6\nu}{d}}}{[M_1 - m_1]^{\frac{d-6}{2}}} \frac{C\beta^{2-\frac{4\nu}{d}}}{[M_3 + m_1]^{\frac{d-4}{2}}}, \\
\text{fifth and sixth diagrams, } & \frac{C\beta^{2-\frac{4\nu}{d}}}{[M_3]^{\frac{d-4}{2}}} \frac{C\beta^{2-\frac{6\nu}{d}}}{[M_2]^{\frac{d-6}{2}}} \frac{C\beta^{2-\frac{6\nu}{d}}}{[M_1]^{\frac{d-6}{2}}}.
\end{aligned} \tag{6.9}$$

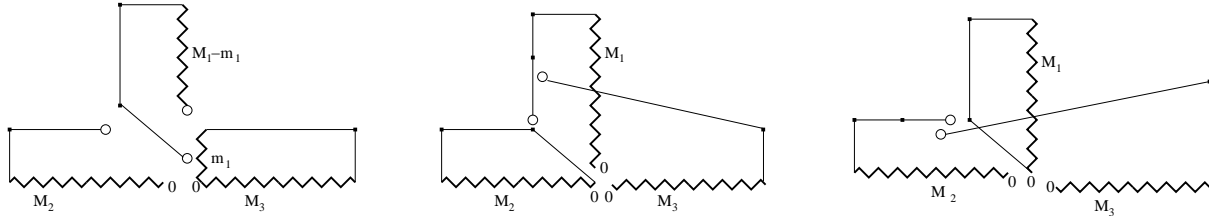

Figure 28: The decomposition of the fourth, fifth and sixth diagrams in Figure 24 into subdiagrams.

The same decompositions above extend immediately to all minimal acyclic laces with 3 bonds covering the branchpoint. This is due to the fact that any bond strictly on branch i can only cover one endpoint of one bond covering the branchpoint (the bond associated to branch i), and on each branch there is at most one such bond (it exists precisely when $N_i > 0$). In most cases the decomposition gives rise to subdiagrams which are either diagrams that we already bounded for the two-point function, such diagrams with an extra vertex, or diagrams that we already bounded for the (acyclic) laces with only two bonds covering the branch point. The exceptions to this rule are the decompositions of the diagrams when m_2 , m_1 , or m_1^* are largest. For the acyclic laces consisting of only 3 bonds (each covering the branchpoint), one of the subdiagrams arising from the decomposition was of the form $\sup_a h_{M_i - m_i} * h_{M_j - m_j} * \rho^{(4)}(a)$, where we used Lemma 5.4 to bound this by $C\beta^{2 - \frac{8\nu}{d}} [M_i - m_i + M_j - m_j]^{-\frac{d-8}{2}}$. For the general (minimal) acyclic laces with 3 bonds covering the branchpoint, one must show that this bound can be generalized when one adds N_i and N_j bonds strictly on branches i and j to obtain a bound $(C\beta^{2 - \frac{8\nu}{d}})^{N_1 + N_2 + 1} [M_i - m_i + M_j - m_j]^{-\frac{d-8}{2}}$. This is easily done either directly by induction on N_1 and N_2 (e.g. as in the proof of Proposition 5.1) or by decomposing the resulting larger diagram into further subdiagrams appearing in Section 5 (in some cases containing an extra vertex on some ρ).

In general our bound on the diagrams arising from (minimal) acyclic laces consisting of N bonds (with N_1 and N_2 fixed), with three bonds covering the branchpoint, is a sum over permutations of branch labels and of all the bounds listed above, with precisely N factors of $C\beta^{2 - \frac{8\nu}{d}}$.

6.3 (Minimal) Cyclic laces

Figure 29 shows the topology and decomposition of the diagram arising from the cyclic laces (with exactly 3 bonds). Without loss of generality, we may assume that $M = M_1$, and we obtain the bound

$$\begin{aligned}
 & \frac{C\beta^{2 - \frac{4\nu}{d}}}{[M]^{\frac{d-4}{2}}} \sum_{m_1 \leq M_1/2} \sum_{m_2 \leq M_2} A^{(2)}(m_1, M_2, M_3) + \\
 & \frac{C\beta^2}{[M]^{\frac{d}{2}}} \sum_{m_1 \geq M_1/2} \sum_{m_2 \leq M_2} \sum_{m_3 \leq M_3} \frac{C\beta^{2 - \frac{4\nu}{d}}}{[m_2 + M_3]^{\frac{d-4}{2}}} \frac{C\beta^{2 - \frac{8\nu}{d}}}{[M_1 - m_1 + M_3 - m_3]^{\frac{d-8}{2}}}.
 \end{aligned} \tag{6.10}$$

As for the (minimal) acyclic laces with 3 bonds covering the branchpoint, the decompositions

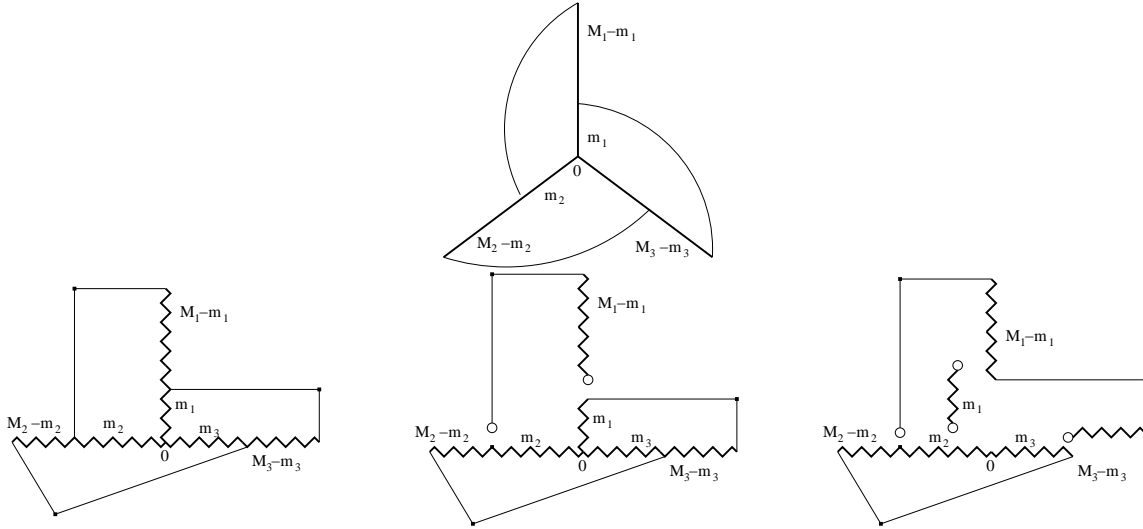

Figure 29: The topology of the minimal cyclic lace with 3 bonds, it's corresponding diagram, and the decomposition, with M_1 assumed to be large.

of the diagrams of general (minimal) acyclic laces do not change. In the case of $m_1 \geq M_1/2$ we must again use the additional diagrammatic estimate discussed near the end of Section 6.2.

In general our bound on the diagrams arising from cyclic laces consisting of N bonds, is a sum over permutations of branch labels and of the bounds listed above, with precisely N factors of $C\beta^{2-\frac{8\nu}{d}}$.

6.4 Proof of Proposition 4.13

We prove the result first for $q = 0$. Recall (4.29) and that (from Section 2.3) the contribution to (4.29) from nonminimal laces containing $N \geq 3$ bonds is bounded by a constant times the contribution from minimal laces containing $N - 1$ bonds. Since $3N/4 - 1 \geq 1/2$ when $N \geq 3$, and using a small factor $(C\beta^{2-\frac{8\nu}{d}})^{N/4}$ (when β is sufficiently small) to perform the sum over N , it is enough to prove the bounds of Proposition 4.13 (with $(C\beta^{2-\frac{8\nu}{d}})^N$ instead of $(C\beta^{2-\frac{8\nu}{d}})^{1/2}$) for the contribution from minimal laces containing exactly N bonds. Keeping N fixed and summing over the possible values of N_1 and N_2 gives a factor of at most N^2 , which can be absorbed into the constant multiplying β since $N^2 \leq 2^N$. We may therefore assume that N_1 and N_2 (and hence N_3) are fixed. As we discussed at the beginning of Section 6, the contribution to $\widehat{\pi}_{\vec{M}}^N(\vec{0})$ from minimal laces with N_1 and N_2 fixed, is bounded by a sum over diagrams that we estimated in Sections 6.1-6.3. Since $N \geq 1$, we have $M = M_1 \vee M_2 \vee M_3 > 0$.

When some $M_i = 0$ (w.l.o.g. $M_3 = 0$), the laces are all laces on an interval of length $M_1 + M_2$ and therefore our bounds of Section 5 give an upper bound on the contribution to the left hand side of (4.31) from such laces of at most $(C\beta^{2-\frac{6\nu}{d}})^N [M_1 \vee M_2]^{-\frac{d-4}{2}}$. Now observe that by symmetry

$$\sum_{\vec{M}: M_j \geq n_j} \frac{1}{[M_1 \vee M_2]^{\frac{d-4}{2}}} \leq 2 \sum_{M_1 \geq n_j} \sum_{M_2 \leq M_1} \frac{1}{M_1^{\frac{d-4}{2}}} \leq 2 \sum_{M_1 \geq n_j} \frac{1}{M_1^{\frac{d-6}{2}}} \leq \frac{1}{n_j^{\frac{d-8}{2}}}, \quad (6.11)$$

so this contribution satisfies the first bound of (4.32). The second bound of (4.32) holds since

$$\sum_{\vec{M} \leq \vec{n}} \frac{M_1 \vee M_2}{[M_1 \vee M_2]^{\frac{d-4}{2}}} \leq 2 \sum_{M_1 \leq \|\vec{n}\|_\infty} \sum_{M_2 \leq M_1} \frac{1}{M_1^{\frac{d-6}{2}}} \leq C \sum_{M_1 \leq \|\vec{n}\|_\infty} \frac{1}{M_1^{\frac{d-8}{2}}} \leq C \begin{cases} \|\vec{n}\|_\infty^{\frac{10-d}{2} \vee 0}, & d \neq 10 \\ \log \|\vec{n}\|_\infty, & d = 10. \end{cases} \quad (6.12)$$

When all $M_i > 0$, for fixed N, N_1, N_2 and topologies of the bonds covering the branchpoint, we established bounds (that depend on N and the topology, but not on N_1 and N_2) on diagrams arising from the corresponding laces, each with N factors of $(C\beta^{2-\frac{8\nu}{d}})$. The contribution to the left hand side of (4.31) from (acyclic) laces with N, N_1, N_2 fixed, and with only two bonds covering the branch point, is bounded by a summing (6.3) and (6.4) (and summing the result over permutations of labels (1, 2, 3)), which are equivalent up to constants and permutations of branch labels since $(M_i \vee M_j) \leq M_i + M_j \leq 2(M_i \vee M_j)$. The finite sums over permutations of branch labels can also be absorbed into the constant multiplying β . Now observe that

$$\sum_{\vec{M}: M_j \geq n_j} \frac{1}{[M_1 \vee M_2]^{\frac{d-4}{2}}} \frac{1}{M_3^{\frac{d-6}{2}}} \leq 2 \sum_{M_1 \geq n_j} \sum_{M_2 \leq M_1} \frac{1}{M_1^{\frac{d-4}{2}}} \sum_{M_3 \leq M_1} \frac{1}{M_3^{\frac{d-6}{2}}} + 2 \sum_{M_3 \geq n_j} \frac{1}{M_3^{\frac{d-6}{2}}} \sum_{M_1 \leq M_3} \sum_{M_2 \leq M_1} \frac{1}{M_1^{\frac{d-4}{2}}}, \quad (6.13)$$

whence the bounds (4.32) hold for the acyclic laces with only two bonds covering the branchpoint.

When all $M_i > 0$, for the contribution to the left hand side of (4.31) from minimal acyclic laces with N, N_1 , and N_2 fixed and with three bonds covering the branchpoint, one must show that all of the diagrammatic bounds in Section 6.2 also satisfy (4.32). Indeed our decompositions were chosen precisely so that this is the case. We show that the result is true for the collection (6.7).

The first bound of (6.7) is at most $M_3^{-\frac{d-6}{2}} (M_1 + M_2)^{-\frac{d-4}{2}}$ which we have already considered above. Using the bounds (6.3) and (6.4) that we obtained for the acyclic laces containing only two bonds, the second bound is at most

$$\frac{1}{M_2^{\frac{d-6}{2}}} \sum_{m_2 \leq M_2} \left(\frac{1}{[M_1 \vee m_2]^{\frac{d-4}{2}} M_3^{\frac{d-6}{2}}} + \frac{1}{[M_3 \vee m_2]^{\frac{d-4}{2}} M_1^{\frac{d-6}{2}}} \frac{1}{[M_1 \vee M_3]^{\frac{d-4}{2}} m_2^{\frac{d-6}{2}}} \right) + \frac{1}{M_2^{\frac{d-4}{2}}} \sum_{m_1 \leq M_1} \frac{1}{(m_1 + M_3)^{\frac{d-4}{2}}}, \quad (6.14)$$

from which we easily obtain (4.32) as above. The third bound of (6.7) is the same up to permutations of the labels (1, 2, 3) and thus we have the result for the collection of diagrammatic bounds (6.7). The proof that the remaining bounds obtained for the minimal acyclic laces with three bonds covering the branch point satisfy (4.32) is similar, as is the corresponding proof for minimal cyclic laces. This completes the proof of Proposition 4.13 when $q = 0$.

It remains to consider the case $q = 1$. If u_j is the displacement of the backbone of branch j , then it can be written as $u_j = y_1 + y_2 + \dots + y_Z$ where the y_i are the displacements of the subwalks of the backbone of branch j , and $Z = Z(j, L) \leq 2N - 1$ depends on the lace L . Then $|u_j|^2 \leq Z \sum_{i=1}^Z |y_i|^2$, and as in the proof of Proposition 5.1 we obtain the bound on $\sum_{\vec{u}} |u_j|^2 \pi_{\vec{m}}^N(\vec{u})$ by using the same diagrammatic estimates, except that one component $h_{m_{j,i}}(y_i)$ of each diagram is replaced by $|y_i|^2 h_{m_{j,i}}(y_i)$. Using the same decompositions as already done previously in this section, and proceeding as usual to bound subdiagrams, the subdiagram containing the

replacement piece $|y_i|^2 h_{m_{j,i}}(y_i)$ is bounded by at most $C\sigma^2 \|M\|_\infty$ times the bound obtained from the original diagram. Thus $\sum_{\vec{u}} |u_j|^2 \pi_{\vec{m}}^N(\vec{u}) \leq C(2N-1) \sum_{i=1}^{2N-1} \sigma^2 \|M\|_\infty \sum_{\vec{u}} \pi_{\vec{m}}^N(\vec{u})$, and we have verified Proposition 4.13 for $q = 1$. \square

6.5 Proof of Lemma 4.11

In this section we prove the three bounds of Lemma 4.11. Fix a skeleton network $\mathcal{N}(\alpha, \vec{n})$, with $\alpha \in \Sigma_r$ and recall Definition 2.1, where b is the branch point neighbouring the root of \mathcal{N} . Let $\mathcal{M} \subseteq \mathcal{N}(\alpha, \vec{n})$. If $U_{st} \in \{-1, 0\}$ for each st , then trivially for any finite collection of disjoint sets $G_i \subset \mathbf{E}_{\mathcal{M}}$,

$$\prod_{st \in \mathbf{E}_{\mathcal{M}}} [1 + U_{st}] \leq \prod_i \prod_{st \in G_i} [1 + U_{st}]. \quad (6.15)$$

We will use this bound frequently, often without explicit reference.

6.5.1 Proof of the first bound of Lemma 4.11

Recall the definition of $\phi_{\mathcal{N}}^{\mathcal{R}}(\vec{y}) \geq 0$ in (4.18), where \mathcal{R} was defined in Definition 2.1 and U_{st} is given by (4.16).

Let \mathcal{N}_e denote the branch of \mathcal{N} corresponding to edge e of α and let $\mathcal{R}^{e,e'} = \{st \in \mathcal{R} : s \in \mathcal{N}_e, t \in \mathcal{N}_{e'}\}$. We claim that when $U_{st} \in \{-1, 0\}$ for all st ,

$$1 - \prod_{st \in \mathcal{R}} [1 + U_{st}] \leq \sum_{\substack{e, e' \in \mathcal{B}_{\mathcal{N}}: \\ \mathcal{N}_e \cap \mathcal{N}_{e'} = \emptyset}} \left(1 - \prod_{st \in \mathcal{R}^{e,e'}} [1 + U_{st}] \right) \leq \sum_{\substack{e, e' \in \mathcal{B}_{\mathcal{N}}: \\ \mathcal{N}_e \cap \mathcal{N}_{e'} = \emptyset}} \sum_{\substack{m_e \leq n_e \\ m_{e'} \leq n_{e'}}} -U_{(e, m_e), (e', m_{e'})}, \quad (6.16)$$

where the sum over e, e' is a sum over pairs of edges of α that do not have an endvertex in common (which can be expressed as $\mathcal{N}_e \cap \mathcal{N}_{e'} = \emptyset$). To verify (6.16), observe that each of the quantities

$$1 - \prod_{st \in \mathcal{R}} [1 + U_{st}], \quad 1 - \prod_{st \in \mathcal{R}^{e,e'}} [1 + U_{st}], \quad -U_{(e, m_e), (e', m_{e'})},$$

are either zero or one. Suppose the left hand side of (6.16) is non-zero. Then there exists some $st \in \mathcal{R}$ with $U_{st} = -1$. By definition of \mathcal{R} , st covers two branch points of \mathcal{N} so that $st \in \mathcal{R}^{e,e'}$ for some e, e' that do not have a common endvertex. For this e and e' , we have $1 - \prod_{st \in \mathcal{R}^{e,e'}} [1 + U_{st}] = 1$ and the first inequality is verified. Now for fixed e, e' , if $1 - \prod_{st \in \mathcal{R}^{e,e'}} [1 + U_{st}]$ is non-zero then there exists $st \in \mathcal{R}^{e,e'}$ with $U_{st} = -1$. But $s = (e, m_e)$, $t = (e', m_{e'})$ for some $m_e \leq n_e$, $m_{e'} \leq n_{e'}$ so that for this m_e and $m_{e'}$, $-U_{(e, m_e), (e', m_{e'})} = 1$. This proves the second inequality.

Examining the second quantity in (2.7) when $U_{st} \in \{-1, 0\}$ for all st we have,

$$\begin{aligned}
0 &\leq \prod_{st \in \mathbf{E}_{\mathcal{N}} \setminus \mathcal{R}} [1 + U_{st}] \left(1 - \prod_{st \in \mathcal{R}} [1 + U_{st}] \right) \leq \sum_{\substack{e, e' \in \mathcal{B}_{\mathcal{N}}: \\ \mathcal{N}_e \cap \mathcal{N}_{e'} = \emptyset}} \sum_{\substack{m_e \leq n_e \\ m_{e'} \leq n_{e'}}} [-U_{m_e, m_{e'}}^{e, e'}] \prod_{st \in \mathbf{E}_{\mathcal{M}} \setminus \mathcal{R}} [1 + U_{st}] \\
&\leq \sum_{\substack{e, e' \in \mathcal{B}_{\mathcal{N}}: \\ \mathcal{N}_e \cap \mathcal{N}_{e'} = \emptyset}} \sum_{\substack{m_e \leq n_e \\ m_{e'} \leq n_{e'}}} [-U_{m_e, m_{e'}}^{e, e'}] \prod_{\substack{f \neq e, e' \\ 0 < s < t < n_f}} \prod_{\substack{s, t \in \mathcal{N}_f: \\ 0 < s < t < n_f}} [1 + U_{st}] \prod_{\substack{s, t \in \mathcal{N}_e: \\ 0 < s < t < m_e}} [1 + U_{st}] \prod_{\substack{s, t \in \mathcal{N}_{e'}: \\ m_e < s < t < n_{e'}}} [1 + U_{st}] \\
&\quad \times \prod_{\substack{s, t \in \mathcal{N}_{e'}: \\ 0 < s < t < m_{e'}}} [1 + U_{st}] \prod_{\substack{s, t \in \mathcal{N}_{e'}: \\ m_e < s < t < n_{e'}}} [1 + U_{st}],
\end{aligned} \tag{6.17}$$

where we have used (6.15) in the final step. Let $\mathcal{N}_{e \rightarrow e'}$ denote the minimal subnetwork of \mathcal{N} connecting branch e to e' , which is nonempty by definition of $\mathcal{R}^{e, e'}$.

Breaking up ω in (4.18) at every branch point and at (e, m_e) and $(e', m_{e'})$ and applying inequality (6.17) we obtain

$$\begin{aligned}
\sum_{\vec{y}} \phi_{\mathcal{N}}^{\mathcal{R}}(\vec{y}) &\leq \rho(o)^{2r-2} \sum_{\substack{e, e' \in \mathcal{B}_{\mathcal{N}}: \\ \mathcal{N}_e \cap \mathcal{N}_{e'} = \emptyset}} \sum_{\substack{m_e \leq n_e \\ m_{e'} \leq n_{e'}}} \left(\prod_{f' \notin (\{e, e'\} \cup \mathcal{N}_{e \rightarrow e'})} \sum_{y_{f'}} h_{n_{f'}}(y_{f'}) \right) \left(\prod_{f \in \mathcal{N}_{e \rightarrow e'}} \sum_{y_f} h_{n_f}(y_f) \right) \times \\
&\quad \sum_{u_e, u_{e'}} h_{m_e}(u_e) h_{m_{e'}}(u_{e'}) \rho^{(2)}(u_e + u_{e'} + \sum_{f \in \mathcal{N}_{e \rightarrow e'}} y_f) \sum_{y_e} h_{n_e - m_e}(y_e - u_e) \sum_{y_{e'}} h_{n_{e'} - m_{e'}}(y_{e'} - u_{e'}) \\
&\leq \rho(o)^{2r-2} K^{2r-4} \sum_{\substack{e, e' \in \mathcal{B}_{\mathcal{N}}: \\ \mathcal{N}_e \cap \mathcal{N}_{e'} = \emptyset}} \sum_{\substack{m_e \leq n_e \\ m_{e'} \leq n_{e'}}} \prod_{f \in \mathcal{N}_{e \rightarrow e'}} \sum_{y_f} h_{n_f}(y_f) \sum_{u_e, u_{e'}} h_{m_e}(u_e) h_{m_{e'}}(u_{e'}) \rho^{(2)}(u_e + u_{e'} + \sum_{f \in \mathcal{N}_{e \rightarrow e'}} y_f) \\
&= \rho(o)^{2r-2} K^{2r-4} \sum_{\substack{e, e' \in \mathcal{B}_{\mathcal{N}}: \\ \mathcal{N}_e \cap \mathcal{N}_{e'} = \emptyset}} \sum_{\substack{m_e \leq n_e \\ m_{e'} \leq n_{e'}}} (h_{m_e} * h_{m_{e'}} * \rho^{(2)})_{f \in \mathcal{N}_{e \rightarrow e'}}^*(h_{n_f})(0),
\end{aligned} \tag{6.18}$$

where the sums over displacements have become a convolution, by change of variables. For every $f \in \mathcal{N}_{e \rightarrow e'}$, this is bounded by

$$\rho(o)^{2r-2} K^{2r-4} \sum_{\substack{e, e' \in \mathcal{B}_{\mathcal{N}}: \\ \mathcal{N}_e \cap \mathcal{N}_{e'} = \emptyset}} \sum_{\substack{m_e \leq n_e \\ m_{e'} \leq n_{e'}}} \frac{C\beta^{2-\frac{4\nu}{d}}}{[m_e + m_{e'} + n_f]^{\frac{d-4}{2}}} \leq C_r \sum_{\substack{e, e' \in \mathcal{B}_{\mathcal{N}}: \\ \mathcal{N}_e \cap \mathcal{N}_{e'} = \emptyset}} \frac{C\beta^{2-\frac{4\nu}{d}}}{n_f^{\frac{d-8}{2}}} \leq C_r \sum_{i=1}^{2r-3} \frac{C\beta^{2-\frac{4\nu}{d}}}{n_i^{\frac{d-8}{2}}},$$

by Lemma 5.4 with $k = 2$ and $l = 2 + \#\mathcal{N}_{e \rightarrow e'}$. This completes the proof of the first bound of Lemma 4.11. \square

6.5.2 Proof of the third bound of Lemma 4.11

Recall the definition of $\phi_{\mathcal{N}}^{\pi}(\vec{y})$ in (4.23), where $\overline{\mathcal{H}}_{\vec{n}_b}$ was defined in (4.21). As in Lemma 4.14, $|\phi_{\mathcal{N}}^{\pi}(\vec{y})|$ is bounded by

$$\begin{aligned} & C \left| \sum_{\vec{m} \in \overline{\mathcal{H}}_{\vec{n}_b}} \sum_{\vec{u}} \pi_{\vec{m}}(\vec{u}) \sum_{\vec{y}} \prod_{i=1}^3 \sum_{v_i} D(v_i - u_i) t_{\mathcal{N}_i^-}(\vec{y}_{v_i}) \right| \\ & \leq C \sum_{N=1}^{\infty} \sum_{\vec{m} \in \overline{\mathcal{H}}_{\vec{n}_b}} \sum_{\vec{u}} \pi_{\vec{m}}^N(\vec{u}) \sum_{\vec{y}} \prod_{i=1}^3 \sum_{v_i} D(v_i - u_i) t_{\mathcal{N}_i^-}(\vec{y}_{v_i}), \end{aligned} \quad (6.19)$$

where $\mathcal{N}_i^- = (\mathcal{N} \setminus \mathcal{S}_{\vec{m}}^{\Delta})$, and \vec{y}_{v_i} denotes the vector of displacements associated to the branches of \mathcal{N}_i^- (determined by \vec{v} , \vec{y} , and the labelling of the branches of \mathcal{N}).

Summing over the v_i and \vec{y} and using (4.4) this is bounded by

$$C \sum_{N=1}^{\infty} \sum_{\vec{m} \in \overline{\mathcal{H}}_{\vec{n}_b}} \sum_{\vec{u}} \pi_{\vec{m}}^N(\vec{u}) \prod_{i=1}^3 K^{\#\mathcal{N}_i^-} \leq C \sum_{N=1}^{\infty} \sum_{j=1}^3 \sum_{\vec{m}: m_j \geq \frac{n_j}{3}} B_N(\vec{m}) \leq \sum_{j=1}^3 \frac{(C\beta^{2-\frac{8\nu}{d}})^{\frac{1}{2}}}{n_j^{\frac{d-8}{2}}}, \quad (6.20)$$

applying Proposition 4.13 in the last line. This verifies the third bound of Lemma 4.11. \square

6.5.3 Proof of the second bound of Lemma 4.11

It follows immediately from the definition of $\phi_{\mathcal{N}}^b(\vec{y})$ in (4.20) that

$$|\phi_{\mathcal{N}}^b(\vec{y})| = \sum_{\omega \in \Omega_{\mathcal{N}}(\vec{y})} W(\omega) \prod_{s \in \mathcal{N}} \sum_{R_s \in \mathcal{T}(\omega(s))} W(R_s) \left| \sum_{\Gamma \in \mathcal{E}_{\mathcal{N}}^b} \prod_{b \in \Gamma} U_b \right|, \quad (6.21)$$

where $\mathcal{E}_{\mathcal{N}}^b$ is defined in Definition 2.1 and is only nonempty if \mathcal{N} contains more than 1 branch point ($r \geq 4$). In particular recall that graphs in $\mathcal{E}_{\mathcal{N}}^b$ contain no bonds in \mathcal{R} . We use an approach similar to that of [20] to analyse $\phi_{\mathcal{N}}^b(\vec{y})$.

Let $G(\mathcal{N}) \subset \{2, 3\}$ be the set of labels of branches of \mathcal{N} incident to b and another branch point of \mathcal{N} . For $F \subset G$ and $e \in F$, let b_e be the other branch point in \mathcal{N} incident to branch \mathcal{N}_e . Let

$$\mathcal{E}_{F, \mathcal{N}}^b = \{\Gamma \in \mathcal{E}_{\mathcal{N}}^b : \text{for every } e \in F, \mathcal{A}_b(\Gamma) \text{ contains a nearest neighbour of } b_e\}.$$

Then,

$$\sum_{\Gamma \in \mathcal{E}_{\mathcal{N}}^b} \prod_{st \in \Gamma} U_{st} = \sum_{\Gamma \in \mathcal{E}_{\{2, \mathcal{N}\}}^b} \prod_{st \in \Gamma} U_{st} + \sum_{\Gamma \in \mathcal{E}_{\{3, \mathcal{N}\}}^b} \prod_{st \in \Gamma} U_{st} - \sum_{\Gamma \in \mathcal{E}_{\{2, 3, \mathcal{N}\}}^b} \prod_{st \in \Gamma} U_{st},$$

where some of these sums could be empty if $G \neq \{2, 3\}$. Thus,

$$\left| \sum_{\Gamma \in \mathcal{E}_{\mathcal{N}}^b} \prod_{st \in \Gamma} U_{st} \right| \leq \sum_{\substack{F \subset G(\mathcal{N}) \\ F \neq \emptyset}} \left| \sum_{\Gamma \in \mathcal{E}_{F, \mathcal{N}}^b} \prod_{st \in \Gamma} U_{st} \right|. \quad (6.22)$$

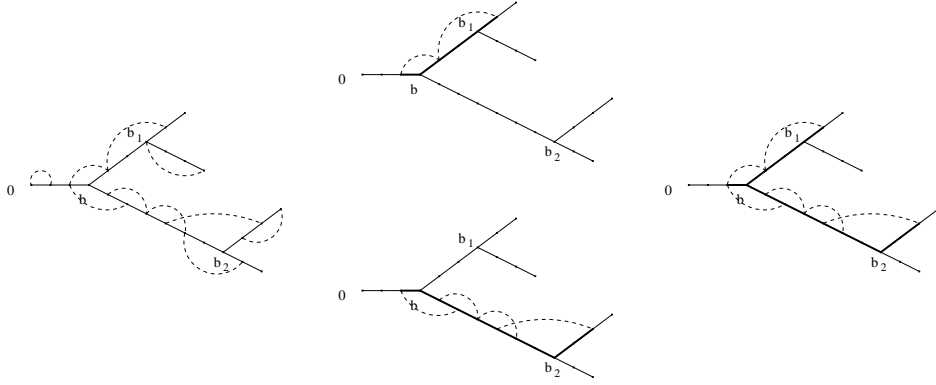

Figure 30: An illustration of the construction of a lace from a graph on some \mathcal{N} in the case $b_1, b_2 \in \mathcal{A}_{\mathcal{N}}(\Gamma)$. The first figure shows a graph Γ on a network \mathcal{N} . The remaining figures highlight the subnetworks $\mathcal{S}_F(\Gamma)$ for $F = \{2\}, \{3\}, \{2, 3\}$.

Note that if $r = 4$ then one of $\mathcal{E}_{\{2\}, \mathcal{N}}^b$ or $\mathcal{E}_{\{3\}, \mathcal{N}}^b$ is empty and $\mathcal{E}_{\{2,3\}, \mathcal{N}}^b$ is empty. This may also be true for $r > 4$, depending on the shape α .

Recall Definition 2.2 and for $\Gamma \in \mathcal{E}_{F, \mathcal{N}}^b$ define $\Gamma_F \subset \Gamma$ to be the set of bonds $st \in \Gamma$ such that

- st is the bond in Γ associated to e at b for some $e \in F$, or
- st is the bond in Γ associated to e at b_e for some $e \in F$ and $b_e \in \mathcal{A}_b(\Gamma)$, or
- $s, t \in \mathcal{N}_e$ for some $e \in F$.

Let $\mathcal{S}_F(\Gamma)$ be the largest subnetwork of \mathcal{N} covered by $\Gamma_F \subset \Gamma$. Clearly $\Gamma|_{\mathcal{S}_F(\Gamma)} = \Gamma_F$ is a connected graph on $\mathcal{S}_F(\Gamma)$.

For each $e \in F$, $\mathcal{S}_F(\Gamma)$ by definition contains a nearest neighbour of b_e in \mathcal{N} , and may contain b_e itself. Since Γ_F contains at most one bond that covers b_e , if $b_e \in \mathcal{S}_F(\Gamma)$ then it is not a branch point of $\mathcal{S}_F(\Gamma)$. Moreover if $F = \{2\}$ or $F = \{3\}$ then b is also not a branch point of $\mathcal{M}_F(\Gamma)$, and hence $\mathcal{S}_F(\Gamma)$ is a network with no branch point (of course it contains at least one branch point of \mathcal{N} , namely b). If $F = \{2, 3\}$ then $\mathcal{S}_F(\Gamma)$ may be a star-shaped network of degree 3.

Fix \mathcal{N} and $F \subset G(\mathcal{N})$. Write $\mathcal{S} \sqsubset_F \mathcal{N}$, if $\mathcal{S} \subset \mathcal{N}$ is a star-shaped network with the following properties:

- (a) for every $e \in F$, \mathcal{S} contains a vertex v that is adjacent to the branch point b_e of \mathcal{N} , and
- (b) \mathcal{S} contains no branch points of \mathcal{N} other than b and b_e , $e \in F$.

Such star-shaped networks are exactly those for which there exists $\Gamma \in \mathcal{G}_{\mathcal{N}}^{-\mathcal{R}}$ such that $\mathcal{S} = \mathcal{S}_F(\Gamma)$. For $\mathcal{S} \sqsubset_F \mathcal{N}$, define $\mathcal{L}_{\mathcal{S}}^F$ to be the set of laces L on \mathcal{S} such that

1. For each e in F , if $b_e \in \mathcal{S}$ then there is exactly one bond $s^e t^e \in L$ covering b_e .
2. If $F = \{2\}$ or $F = \{3\}$ then there is exactly one bond in $\mathcal{L}_{\mathcal{S}}^*$ covering b , while if $F = \{2, 3\}$ there are at most 2 bonds in $\mathcal{L}_{\mathcal{S}}^*$ covering b .

3. L contains no elements of \mathcal{R} (i.e. no bonds which cover ≥ 2 branch points of \mathcal{N}).

Then recalling the definition of \mathbf{L}_Γ from Definition 2.4 we have

$$\begin{aligned} \sum_{\Gamma \in \mathcal{E}_{F,\mathcal{N}}^b} \prod_{st \in \Gamma} U_{st} &= \sum_{S \sqsubset \mathcal{N}} \sum_{\substack{\Gamma \in \mathcal{E}_{F,\mathcal{N}}^b \\ \mathcal{S}_F(\Gamma) = S}} \prod_{st \in \Gamma} U_{st} = \sum_{S \sqsubset F, \mathcal{N}} \sum_{L \in \mathcal{L}_S^F} \left[\prod_{st \in L} U_{st} \right] \left[\sum_{\substack{\Gamma \in \mathcal{E}_{F,\mathcal{N}}^b \\ \mathcal{S}_F(\Gamma) = S, \mathbf{L}_{\Gamma_F} = L}} \prod_{s't' \in \Gamma \setminus L} U_{s't'} \right] \\ &= \sum_{S \sqsubset F, \mathcal{N}} \sum_{L \in \mathcal{L}_S^F} \left[\prod_{st \in L} U_{st} \right] \left[\sum_{\substack{\Gamma \in \mathcal{G}_S^{-\mathcal{R}, \text{con}} \\ \mathbf{L}_\Gamma = L}} \prod_{st \in \Gamma \setminus L} U_{st} \right] \left[\sum_{\Gamma' \in \mathcal{G}_{\mathcal{N} \setminus S}^{-\mathcal{R}}} \prod_{st \in \Gamma'} U_{st} \right] \sum_{\substack{\Gamma^* \in \mathcal{G}_{S, \mathcal{N} \setminus S}^{-\mathcal{R}} \\ \mathcal{S}_F(L \cup \Gamma^*) = S}} \prod_{st \in \Gamma^*} U_{st}, \end{aligned} \quad (6.23)$$

where

$$\mathcal{G}_{S, \mathcal{N} \setminus S}^{-\mathcal{R}} = \{\Gamma \in \mathcal{G}^{-\mathcal{R}} : \text{for every } st \in \Gamma, [s \in S, t \in \mathcal{N} \setminus S] \text{ or } [t \in S, s \in \mathcal{N} \setminus S]\}.$$

Let $\mathcal{L}_S^{N,F}$ be the set of laces in \mathcal{L}_S^F consisting of exactly N bonds. Now observe that if \mathcal{H} is the power set of a finite set \mathcal{B}^* (i.e. the set of all subsets of \mathcal{B}) then $\sum_{\Gamma \in \mathcal{H}} \prod_{b \in \Gamma} U_b = \prod_{\{b\} \in \mathcal{B}^*} [1 + U_b]$. Applying this to the set \mathcal{B}^* of bonds on $\mathcal{N} \setminus S$ (excluding \mathcal{R}) and similarly for the final sum of (6.23), we see that (6.23) is equal to

$$\sum_{N=1}^{\infty} (-1)^N \sum_{S \sqsubset F, \mathcal{N}} \sum_{L \in \mathcal{L}_S^{N,F}} \left[\prod_{st \in L} -U_{st} \right] \left[\prod_{st \in \mathcal{C}(L)} [1 + U_{st}] \right] \left[\prod_{\substack{st \in \mathbf{E}_{\mathcal{N} \setminus S} \\ st \notin \mathcal{R}}} [1 + U_{st}] \right] \left[\prod_{\substack{s \in S, t \in \mathcal{N} \setminus S \\ \mathcal{S}_F(L \cup st) = S, st \notin \mathcal{R}}} [1 + U_{st}] \right]. \quad (6.24)$$

If $U_{st} \in \{-1, 0\}$ for each st , then each quantity involving U_{st} in (6.24) is nonnegative and we have

$$\left| \sum_{\Gamma \in \mathcal{E}_{F,\mathcal{N}}^b} \prod_{st \in \Gamma} U_{st} \right| \leq \sum_{N=1}^{\infty} \sum_{S \sqsubset F, \mathcal{N}} \sum_{L \in \mathcal{L}_S^{N,*}} \left[\prod_{st \in L} -U_{st} \right] \left[\prod_{st \in \mathcal{C}(L)} [1 + U_{st}] \right] \prod_{i=1}^{\Delta_{\mathcal{N} \setminus S}} \left[\prod_{\substack{st \in \mathbf{E}_{(\mathcal{N} \setminus S)^i} \\ st \notin \mathcal{R}}} [1 + U_{st}] \right], \quad (6.25)$$

where $\Delta_{\mathcal{N} \setminus S}$ is the number of disjoint components $(\mathcal{N} \setminus S)_i$ of $\mathcal{N} \setminus S$. This quantity is bounded above by the sum of four terms (corresponding to the 4 possible branches incident to b_2 and b_3 if $F = \{2, 3\}$) each of the form

$$\begin{aligned} &\sum_{N=1}^{\infty} \left(\prod_{e \in F} \sum_{m_e = n_e - 1}^{n_e + (n_{e'} - 1)} \right) \sum_{m_1=0}^{n_1} \left(\prod_{e \in \{2,3\} \setminus F} \sum_{m_e=0}^{n_e} \right) \sum_{L \in \mathcal{L}_{\bar{m}}^N} \left[\prod_{st \in L} -U_{st} \right] \left[\prod_{st \in \mathcal{C}(L)} [1 + U_{st}] \right] \times \\ &\prod_{i=1}^{\Delta_{\mathcal{N} \setminus S} \Delta_{\bar{m}}} \prod_{\bar{e} \in (\mathcal{N} \setminus S_{\bar{m}} \Delta_{\bar{m}})^i} \left[\prod_{\substack{s, t \in ((\mathcal{N} \setminus S_{\bar{m}} \Delta_{\bar{m}})^i)_{\bar{e}} \\ 0 < s < t < n_{\bar{e}}(\bar{m})^i}} [1 + U_{st}] \right], \end{aligned} \quad (6.26)$$

where e' denotes one of the two branches (other than e) incident to b_e , $\mathcal{S}_{\vec{m}}^\Delta$ is the star-shaped network defined by (2.18), and $(\mathcal{N} \setminus \mathcal{S}_{\vec{m}}^\Delta)^{n_i}$ denotes the fact that part of branch $\mathcal{N}_{e'}$ is being removed if $m_e \geq n_e$. In addition $n_{\bar{e}}(\vec{m})^{n_i}$ is the length of branch \bar{e} of $(\mathcal{N} \setminus \mathcal{S}_{\vec{m}}^\Delta)^{n_i}$. Since the analysis does not depend on the e' , we ignore the fact that there are 4 such terms from this point on.

Combining (6.22), (6.25) and (6.26) we have that $\left| \sum_{\Gamma \in \mathcal{E}_{\mathcal{N}}^b} \prod_{st \in \Gamma} U_{st} \right|$ is bounded by a constant times

$$\sum_{\substack{F \subset G(\mathcal{N}) \\ F \neq \emptyset}} \sum_{N=1}^{\infty} \left(\prod_{e \in F} \sum_{m_e = n_e - 1}^{n_e + (n_{e'} - 1)} \right) \sum_{m_1=0}^{n_1} \left(\prod_{e \in \{2,3\} \setminus F} \sum_{m_e=0}^{n_e-1} \right) \times \sum_{L \in \mathcal{L}_{\mathcal{S}_{\vec{m}}^\Delta}^N} \left[\prod_{st \in L} -U_{st} \right] \left[\prod_{st \in \mathcal{C}(L)} [1 + U_{st}] \right]^{\Delta_{\mathcal{N} \setminus \mathcal{S}_{\vec{m}}^\Delta}} \prod_{i=1} \prod_{\bar{e} \in (\mathcal{N} \setminus \mathcal{S}_{\vec{m}}^\Delta)^{n_i}} \left[\prod_{\substack{s,t \in ((\mathcal{N} \setminus \mathcal{S}_{\vec{m}}^\Delta)^{n_i})_{\bar{e}}: \\ 0 < s < t < n_{\bar{e}}(\vec{m})^{n_i}}} [1 + U_{st}] \right]. \quad (6.27)$$

Putting this back into (6.21), the sum over laces on the star-shaped network gives rise to the quantity $\pi_{\vec{m}}(\cdot)$ and the final product gives rise to at most a constant times $h_{n_{\bar{e}}(\vec{m})^{n_i}}(\cdot)$, with displacements summed over. We use Lemma 5.10) with $l = 1, q = 0$ to bound $\|h_{n_{\bar{e}}(\vec{m})^{n_i}}\|_1$ by a constant and we obtain an upper bound on (6.21) of a constant times

$$\sum_{\substack{F \subset G(\mathcal{N}) \\ F \neq \emptyset}} \sum_{N=1}^{\infty} \left(\prod_{e \in F} \sum_{m_e = n_e - 1}^{n_e + (n_{e'} - 1)} \right) \sum_{m_1=0}^{n_1} \left(\prod_{e \in \{2,3\} \setminus F} \sum_{m_e=0}^{n_e-1} \right) \sum_{\vec{u}} \pi_{\vec{m}}^N(\vec{u}) \prod_{i=1}^{\Delta_{\mathcal{N} \setminus \mathcal{S}_{\vec{m}}^\Delta}} \prod_{\bar{e} \in (\mathcal{N} \setminus \mathcal{S}_{\vec{m}}^\Delta)^{n_i}} K. \quad (6.28)$$

By Proposition 4.13 this is bounded above by

$$C \sum_{\substack{F \subset G(\mathcal{N}) \\ F \neq \emptyset}} \sum_{N=1}^{\infty} \left(\prod_{e \in F} \sum_{m_e = n_e - 1}^{n_e + (n_{e'} - 1)} \right) \sum_{m_1=0}^{n_1} \left(\prod_{e \in \{2,3\} \setminus F} \sum_{m_e=0}^{n_e-1} \right) B_N(\vec{m}) \leq C \sum_{\substack{F \subset G(\mathcal{N}) \\ F \neq \emptyset}} \sum_{e \in F} \frac{C \beta^{2 - \frac{8\nu}{d}}}{n_e^{\frac{d-8}{2}}}. \quad (6.29)$$

Since the remaining sums are finite, this establishes the second bound of Lemma 4.11, and hence completes the proof of Lemma 4.11. \square

Acknowledgments

This work was supported by the following awards from the University of British Columbia: Killam Predoctoral Fellowship, Josephine T. Berthier Memorial Fellowship and John R. Grace Fellowship. The author would like to thank those associated with the foundation and the administration of these awards.

The author would especially like to thank Gordon Slade, Edwin Perkins and Remco van der Hofstad for their ideas and encouragement. Thanks also to Akira Sakai for helpful discussions while at Eurandom.

Finally the author would like to thank two anonymous referees for pointing out numerous typos and giving many helpful suggestions for the improvement of the paper, including giving the much shorter proof of Lemma 3.9 that appears in this version.

References

- [1] R. Adler. Superprocess local and intersection local times and their corresponding particle pictures. In *Seminar on Stochastic Processes 1992*. Birkhäuser, Boston, 1993. MR1278075
- [2] D. Aldous. Tree-based models for random distribution of mass. *J. Stat. Phys.*, 73:625–641, 1993. MR1251658
- [3] D. Brydges and J. Imbrie. Dimensional reduction formulas for branched polymer correlation functions. *J. Stat. Phys.*, 110:503–518, 2003. MR1964682
- [4] D. Brydges and T. Spencer. Self-avoiding walk in 5 or more dimensions. *Commun. Math. Phys.*, 97:125–148, 1985. MR0782962
- [5] D. Dawson, I. Iscoe, and E. Perkins. Super-Brownian motion: path properties and hitting probabilities. *Probab. Theory Relat. Fields.*, 83:135–205, 1989. MR1012498
- [6] E. Derbez and G. Slade. The scaling limit of lattice trees in high dimensions. *Commun. Math. Phys.*, 193:69–104, 1998. MR1620301
- [7] J. Fröhlich. Mathematical aspects of the physics of disordered systems. In *Phénomènes critiques, systèmes aléatoires, théories de jauge, Part II*. North-Holland, Amsterdam, 1986. MR0880538
- [8] T. Hara, R. van der Hofstad, and G. Slade. Critical two-point functions and the lace expansion for spread-out high-dimensional percolation and related models. *Ann. Probab.*, 31:349–408, 2003. MR1959796
- [9] T. Hara and G. Slade. On the upper critical dimension of lattice trees and lattice animals. *J. Stat. Phys.*, 59:1469–1510, 1990. MR1063208
- [10] T. Hara and G. Slade. The number and size of branched polymers in high dimensions. *J. Stat. Phys.*, 67:1009–1038, 1992. MR1170084
- [11] T. Hara and G. Slade. The scaling limit of the incipient infinite cluster in high-dimensional percolation. i. critical exponents. *J. Stat. Phys.*, 99:1075–1168, 2000. MR1773141
- [12] T. Hara and G. Slade. The scaling limit of the incipient infinite cluster in high-dimensional percolation. ii. integrated super-brownian excursion. *J. Math. Phys.*, 41:1244–1293, 2000. MR1757958
- [13] R. van der Hofstad, F. den Hollander, and G. Slade. The survival probability for critical spread-out oriented percolation above $4+1$ dimensions. I. Induction. *Probab. Theory Relat. Fields.*, 138:363–389, 2007. MR2299712

- [14] R. van der Hofstad, F. den Hollander, and G. Slade. The survival probability for critical spread-out oriented percolation above $4+1$ dimensions. II. Expansion. *Ann. Inst. H. Poincaré Probab. Statist.*, 43:509–570, 2007. MR2347096
- [15] R. van der Hofstad, M. Holmes, and G. Slade. An extension of the generalised inductive approach to the lace expansion. Preprint, 2007.
- [16] R. van der Hofstad and A. Sakai. Convergence of the critical finite-range contact process to super-Brownian motion above 4 spatial dimensions. *In preparation*, 2007.
- [17] R. van der Hofstad and G. Slade. A generalised inductive approach to the lace expansion. *Probab. Theory Relat. Fields.*, 122:389–430, 2002. MR1892852
- [18] R. van der Hofstad and G. Slade. Convergence of critical oriented percolation to super-Brownian motion above $4+1$ dimensions. *Ann. Inst. H. Poincaré Probab. Statist.*, 39(3):413–485, 2003. MR1978987
- [19] R. van der Hofstad and G. Slade. The lace expansion on a tree with application to networks of self-avoiding walks. *Adv. Appl. Math.*, 30:471–528, 2003. MR1973954
- [20] M. Holmes, A. Járai, A. Sakai, and G. Slade. High-dimensional graphical networks of self-avoiding walks. *Canadian Journal Math.*, 56:77–114, 2004. MR2031124
- [21] M. Holmes and E. Perkins. Weak convergence of measure-valued processes and r -point functions. *Ann. Probab.*, 35:1769–1782, 2007. MR2349574
- [22] J. Klein. Rigorous results for branched polymer models with excluded volume. *J. Chem. Phys.*, 75:5186–5189, 1981.
- [23] T. Lubensky and J. Isaacson. Statistics of lattice animals and dilute branched polymers. *Phys. Rev.*, A20:2130–2146, 1979.
- [24] N. Madras and G. Slade. *The Self-Avoiding Walk*. Birkhäuser, Boston, 1993. MR1197356
- [25] E. Perkins. Dawson-Watanabe superprocesses and measure-valued diffusions. In *Lectures on Probability Theory and Statistics, no. 1781, Ecole d’Eté de Probabilités de Saint Flour 1999*. Springer, Berlin, 2002. MR1915445
- [26] G. Slade. *The lace expansion and its applications*, volume 1879 of *Lecture Notes in Mathematics*. Springer-Verlag, Berlin, 2006. MR2239599
- [27] W. Werner. Random planar curves and Schramm-Loewner evolutions. In *Lectures on Probability Theory and Statistics, no. 1840, Ecole d’Eté de Probabilités de Saint Flour 2002*. Springer, Berlin, 2004. MR2079672